

MINERWA 25

CONDENSING COMBI BOILER
INSTALLATION & USER MANUAL





MINERWA 25

INDEX

1. DEAR WARMHAUS CUSTOMER	4
1.1. GENERAL WARNINGS.....	4
1.2. GENERAL WARRANTY CONDITIONS	4
1.3. BOILER GAS CATEGORIES & DESTINATIONS	6
1.4. GAS LEAKAGES	8
2. INSTALLATION PERSONNEL SECTION	9
2.1. CONTENTS OF PACKING BOX.....	9
2.2. COMBI BOILER INSTALLATION RULES.....	10
2.2.1. General Rules for Installation Places of Combi Boilers.....	10
2.2.2. Places Not Suitable for Installing Hermetical Combi Boilers.....	10
2.2.3. Wall Installation of Combi Boiler and Selecting the Installation Place.....	10
2.2.4. Dimensions and Connections.....	11
2.2.5. Natural Gas and LPG Connection (Device Category I _{2H} , II _{2H3P})	11
2.2.6. Flammable Gas Quality	11
2.2.7. In Case of Using LPG Tank.....	11
2.2.8. In Case of Using Bottled Gas	11
2.2.9. Filling the siphon for Condensation Line.....	12
2.2.10. Installation at Partially Protected Exteriors	12
2.2.11. Electrical Connections.....	13
2.2.12. Optional Controls: Room Thermostat, Outside Sensor and Others.....	13
2.3. HYDRAULIC INSTALLATION RULES	15
2.3.1. Radiator and DHW Installations.....	15
2.3.2. Filling/Emptying Radiator Installation.....	15
2.3.3. Circulation Pump.....	17
2.3.4. Controls for Initial Operation of Combi Boiler	17
2.4. COMBI BOILER FLUE CONNECTIONS.....	19
2.4.1. Exhaust Gas Flue Pipe Set and Accessories Connection	19
2.4.2. COMBI BOILER FLUE CONNECTION TYPES	19
2.4.3. Peripheral Distances of Flue Output Connections	23
2.4.4. Installation with Horizontal Flue Sets	24
2.4.5. Installation with Vertical Flue Sets (Ø60/100 mm).....	25
2.4.6. Twin Flue Kits Ø 80/80 Flue Type Use	26
2.4.7. Recommendations of Plume Kit Installation	31
3. USER'S SECTION.....	32
3.1. GENERAL WARNINGS FOR USER.....	32
3.1.1. Use of Combi Boiler	32
3.1.2. Selection of On/Off/Stand-by and Summer/Winter Modes	33
3.1.3. On/Off/Stand-by Positions	33
3.1.4. Operation in Winter Mode.....	34
3.1.5. Operation at Summer Position.....	34
3.1.6. Use with Room Thermostat (Optional)	35
3.1.7. Use of Outside Temperature Sensor (Optional).....	35
3.1.8. Customizing Combi Boiler Features	36
3.2. RECOMMENDATIONS FOR ECONOMICAL USE OF COMBI BOILER.....	45
3.3. ISSUES REQUIRED TO BE TAKEN INTO CONSIDERATION FOR WARRANTY CONDITIONS.....	45

1. DEAR WARMHAUS CUSTOMER

We congratulate you for preferring the Warmhaus combi boiler to maintain your heating and hot use water comfort for long years and thank for your trust. Warmhaus combi boiler, manufactured in accordance with EU standards and advanced technology, are also being imported to many countries. You can benefit from our Authorized Technical Service network having occupational competency certificate for all kinds of ordinary maintenance requirements for this product manufactured with rigorous studies. Our Authorized Services guarantee protection of your device performance as they always provide original spare parts service. Read this guide carefully in order to use the combi boiler in an economic, comfortable and efficient way and keep as a source of application.

In order to ensure efficient use, we initially recommend you to have the installation performed by a certified dealer experienced and competent in installation by the local gas authority.

1.1. GENERAL WARNINGS

Guide Book is an inseparable and integral part of the product and should be delivered to the new user when the device is transferred. This book should be carefully protected and referred to when necessary, as it contains important information regarding installation and operation of the product.



Radiator and DHW installations should be performed by a competent and certified engineering company in accordance with measurements defined based on laws by considering legal regulations in force.



Installation and Maintenance operations should be performed by the expert personnel having adequate technical knowledge in installations sector and occupational competency certificate in accordance with legal regulations in force. As the result of a false installation, dangers may occur which the manufacturer company cannot be held responsible for and may damage people, other live beings (animals, plants) or commodities.



Natural Gas Installation Project; One of the dealers authorized by a gas company located at your city should be preferred for performing project and etude studies.



In order to enable use of the combi boiler with LPG bottles or LPG tanks, conversation of the combi boiler should be performed by our authorized Warmhaus service. Project design and application for LPG use should be performed by the company supplying the tank in accordance with local and legal rules.

1.2. GENERAL WARRANTY CONDITIONS



The Manufacturer company shall not have any responsibilities within or out of the agreement scope due to failures arising from failing to follow legal regulations in force and standards and information given in this guide book (and information and instructions provided by the manufacturer under any circumstances) during installation, use or maintenance operations and device warranty shall also be void.



Only the authorized Warmhaus Service is authorized to make the electrical connection of combi boiler and supplying electricity to the combi boiler.

The maintenance and repairs as the result of failure of the product within the warranty period due to material, production and installation errors shall be performed as free of charge without claiming any workmanship costs and spare part payments.

(Also See: 3.5. ISSUES REQUIRED TO BE TAKEN INTO CONSIDERATION BY USERS FOR WARRANTY CONDITIONS)



This device should only be used for its designed intended purposes (to be used in closed-circuit heater installation and production of open circuit domestic hot water production). All kinds of other uses are not suitable and may create a potential danger.

Manufacturer shall not be responsible for damages occurring due to interventions, false installation and initial starting performed by unauthorized persons and warranty scope shall be void. As the combi boiler is a device having heating system, domestic hot water, natural gas/LPG and electrical connections, do not make and have any interventions made without the authorized service.



Any interference with a sealed component is forbidden.



Device maintenance operations should be performed by the authorized and expert technical personnel.



Children must not operate the combi boiler.



This device has been manufactured to be installed in the country given on the technical registry label. Performing the installation in countries other than the country written on the table may damage individuals, animals and commodities.

Combi boilers bear CE mark in accordance with below given directives:

- Gas Appliances Directive 2009/142/EC
- Boiler Efficiency Directive 92/42/EEC
- Low Voltage Directive 2014/35/EU
- Electromagnetic Compatibility Directive 2014/30/EU

Please visit the below given web site of Warmhaus for acquiring more detailed information regarding legal regulations on installation of gas fired heating devices: www.warmhaus.com

Manufacturer: WARMHAUS Isıtma ve Soğutma Sistemleri Tic. A.Ş. Bursa Işıktepe OSB Mah. Park Cad. No:10 16140 Nilüfer-Bursa / Türkiye

WARMHAUS

Warmhaus Authorized Technical Service Centres maintain an assurance regarding quality and professionalism. WARMHAUS is not responsible for damages arising from repairs, part replacements and maintenances performed by third persons and companies and product remains out of the warranty scope under such conditions.



WARMHAUS A.Ş. reserves the right to make all kinds of technical and commercial amendments without giving information and rejects all responsibilities depending on misspelling.

1.3. BOILER GAS CATEGORIES & DESTINATIONS

Designation: Used gas types & Countries		
Object Manufacturer	Type-model / Technical data	Mark (s) of conformity
Boiler gas categories & destinations	Warmhaus all wall-hung boilers	granted
<p>Gas categories for Warmhaus boilers applied on CE certification on SZU Test / BRNO are given below;</p> <p>- the appliance category(ies) in relation to the direct countries of destination has been specified EN 15502-1; GAR Certificate E-30-00300-18 product ID Nr. CE-1015CT0615</p> <p>- the country(-ies) of destination, in accordance with EN ISO 3166-1;</p> <p>- the gas supply pressure in millibars, if several normal pressures can be used for the same gas group. They are indicated by their numerical value and the unit "mbar"</p>		

Document for conformity approved by SZU test	Appliance Categories	Gas Type	Gas Inlet Supply Pressures	Used Gas	Minerwa 25	Countries of Destination **
YES	I 2H	Natural Gas	20 mbar	G20	Available	AT, BG, CH, CZ, DK, EE, ES, FI, GB, GR, HR, IE, IT, LT, LU, LV, NO, PT, RO, SE, SI, SK, TR
YES	I 2H	Natural Gas	25 mbar	G20	Available	HU
YES	I 2E	Natural Gas	20 mbar	G20	Available	DE, LU, PL, RO
YES	I 2E+	Natural Gas	20 mbar	G20	Available	BE, FR
YES	I 2E(S)	Natural Gas	20 mbar	G20	Available	BE
YES	I 2ELL	Natural Gas	20 mbar	G20	Available	DE
YES	II 2H3P	Natural Gas	20 mbar	G20	Available	CH, CZ, ES, GB, GR, HR, IE, IT, LT, PT, RO, SI, SK
YES	II 2H3+	Natural Gas	20 mbar	G20	Available	CH, CY, CZ, ES, GB, GR, IE, IT, LT, PT, SI, SK, TR
YES	II 2E+3+	Natural Gas	20 mbar 25 mbar	G20	Available	BE, FR
YES	II 2E+3P	Natural Gas	20 mbar 25 mbar	G20	Available	BE, FR
YES	II 2H3B/P	Natural Gas	20 mbar	G20	Available	AT, CH, CY, CZ, DK, EE, FI, GR, IT, LT, NO, RO, SE, SI, SK
YES	II 2E3B/P	Natural Gas	20 mbar	G20	Available	DE
YES	II 2ELL3B/P	Natural Gas	20 mbar	G20	Available	DE
YES	I 2L	Natural Gas	25 mbar	G25	Available	NL
YES	I 2E+	Natural Gas	25 mbar	G25	Available	BE, FR
YES	I 2ELL	Natural Gas	20 mbar	G25	Available	DE
YES	II 2L3P	Natural Gas	25 mbar	G25	Available	NL
YES	II 2L3B/P	Natural Gas	25 mbar	G25	Available	NL
YES	II 2ELL3B/P	Natural Gas	20 mbar	G25	Available	DE
YES	I 3+	Buthane Gas	28-30 mbar 37 mbar	G30	Available	BE, CH, CY, CZ, ES, FR, GB, GR, IE, IT, LT, PT, SI, SK
YES	I 3B/P	Buthane Gas	30 mbar	G30	Available	BE, CY, CZ, DK, EE, FI, GB, GR, HU, HR, IT, LT, NL, NO, RO, SE, SI, SK, TR

Document for conformity approved by SZU test	Appliance Categories	Gas Type	Gas Inlet Supply Pressures	Used Gas	Minerwa 25	Countries of Destination **
YES	I 3B/P	Buthane Gas	50 mbar	G30	Available	AT, CH, DE, FR, SK
YES	II 2H3+	Buthane Gas	28-30 mbar 37 mbar	G30	Available	CH, CY, CZ, ES, GB, GR, IE, IT, LT, PT, SI, SK, TR
YES	II 2E+3+	Buthane Gas	28-30 mbar 37 mbar	G30	Available	BE, FR
YES	II 2H3B/P	Buthane Gas	30 mbar	G30	Available	CY, CZ, DK, EE, FI, GR, IT, LT, NO, RO, SE, SI, SK
YES	II 2H3B/P	Buthane Gas	50 mbar	G30	Available	AT, CH, SK
YES	II 2E3B/P	Buthane Gas	50 mbar	G30	Available	DE
YES	II 2L3B/P	Buthane Gas	30 mbar	G30	Available	NL
YES	II 2ELL3B/P	Buthane Gas	50 mbar	G30	Available	DE
YES	I 3P	Propane LPG	37 mbar	G31	Available	BE, CH, CZ, ES, FR, GB, GR, HR, IE, IT, LT, NL, PL, PT, SI, SK, TR
YES	II 2H3P	Propane LPG	37 mbar	G31	Available	CH, CZ, ES, GB, GR, HR, IE, IT, LT, PT, RO, SI, SK
YES	II 2L3P	Propane LPG	37 mbar	G31	Available	NL
YES	II 2E+3P	Propane LPG	37 mbar	G31	Available	BE, FR
YES	II 2E+3P	Propane LPG	37 mbar	G31	Available	BE, FR

** EN 437+A1:2009, Codes for the representation of gases and names of countries and their subdivisions; Part 1: Country codes (ISO 3166-1:2006)

1.4. GAS LEAKAGES

HOW TO MOVE WHEN NATURAL GAS ODOUR IS DETECTED..



Do not use lighter - matches.



Do not light on and off lamps and other electrical devices or pull off the plug.



Ventilate the environment by opening doors and windows.



Close valves of devices operating with natural gas and your gas meter.



Do not use the door bell.



Do not use phones in case of a natural gas leakage. It may create sparks.



Immediately evacuate the place with gas odour.



Natural Gas Emergency Line from your neighbour or another suitable place.



Do not make any intervention on installation.



Never close culverts ensuring discharge of the gas from the environment in case of a natural gas leakage.

DURING EMERGENCIES



NATURAL GAS EMERGENCY



FIRE DEPARTMENT



AMBULANCE



POLICE

INFORMATION: You can visit web sites of local gas authorities and **NATURAL GAS EMERGENCY** sections.

Advice: Please take note local emergency phone numbers.

2. INSTALLATION PERSONNEL SECTION

2.1. CONTENTS OF PACKING BOX

Warmhaus is sold as two boxes with combi boiler and flue set. Combi boiler box contains below listed materials and small box contains exhaust gas flue pipes.

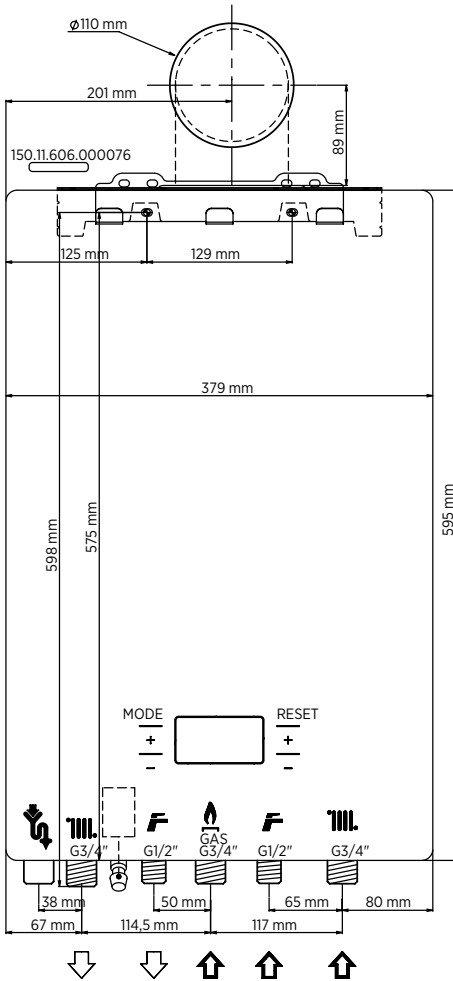

Figure 1 Installation scheme

- I. Installation Scheme (Figure 1)
- II. User's Guide (Figure 2)
- III. Connection Accessories (Figure 3)
 - a. 2 screws
 - b. 2 Dowels
- IV. Hanging Plate (Figure 4)
- V. Exhaust Gas Flue Set (Figure 5)



Figure 2 User's Guide



Figure 3 Connection accessories

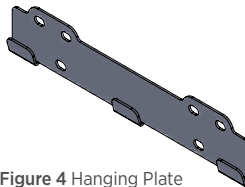



Figure 4 Hanging Plate



Figure 5 Exhaust gas flue set

 Do not leave packing materials (plastic, nylon, bags, etc.) at places to be reached by children for preventing any dangers for health.

2.2. COMBI BOILER INSTALLATION RULES

2.2.1. General Rules for Installation Places of Combi Boilers

No restriction is available for places where Hermetic (C typ) combi boiler is installed (devices may be installed regardless the room volume and ventilation type). Also, they may be installed at partially protected areas such as balcony, terrace provided that being placed in protective cabinets and taking required precautions against frost of installation water.

Combi boiler should be soundly installed to building wall. Flexible connection piece should be used between the combi boiler and gas line. Flex lengths to be used in A, B and C type devices should not exceed dimensions allowed by local gas authorities. Flue outputs of hermetic combi boilers must be connected to places open to exterior and having air circulation. Installation (positions of pipe output opening based on various forms, vertical, horizontal minimum distances, cross section areas of channels if given to channels, etc.) must be carried out according to regulation standards, current legislation and in compliance with local technical regulations and the required technical procedures.

2.2.2. Places Not Suitable for Installing Hermetical Combi Boilers

- Stairways of Buildings,
- Corridors available for general use, ventilation ways and shafts, lofts, attics, emergency exit doors, cellars, hall and similar places creating common use areas,
- Yards between buildings,
- Narrow cornice distances,
- Over flue walls,
- Enclosed balconies,
- Open balconies (except being located in the cabinet and permission of the device company),
- Below protruding structure parts preventing exhaust gas output,
- Places those may be directly subjected to wind resistance,
- Openings providing clean air to other units!

2.2.3. Wall Installation of Combi Boiler and Selecting the Installation Place

- It should be controlled and ensured that the wall installation of the combi boiler is sound and reliable.
- The hanging plate given as standard with the combi boiler should be installed according to the technique to full or semi-full brick wall according to installation scheme and with connection screws and not to be used for other purposes.
- In case of using different materials for installation, combi boiler shall be out of the warranty scope.
- If the wall of installation is not a brick wall, initially the reliability of support system should be controlled.
- Combi boiler should be installed on a wall resistant to fire.

- NOTICE: Combustible and corrosive materials:
 - a) Chemically aggressive substances can corrode the appliance and invalidate any guarantee.
 - b) Do not store or use any combustible materials (paper, thinners, paints, propellants, cleaning agents etc.) Keep the distance minimum 50 cm.
 - c) 1,8 - 2,2 m height is recommended for installation of the boiler hanging plate.
- For places with limited installation place, boiler should be installed at minimum 30 cm height from ground and by leaving at least 5 cm distances from both sides in order to allow easy access of the service technician.
- Combi boiler installation must not performed in environments containing explosive, flammable substances and acid fumes
- Installation cannot be made near or above ovens, radiators or heater devices.
- Hermetic combi boilers can be installed in furnitures but at least 5 cm should be left at both sides.
- If to be installed above the kitchen countertops or the set, at least 30 cm distance should be left under the combi boiler.
- It is recommended to connect the output to drain line with a transparent hose against the possibility of water leakage from Safety Valve of combi boiler during installation. If this is not possible; do not place electronic devices, delicate, corrodible devices, components and tools under the combi boiler.
- Do not place/use any furnitures below the combi boiler due to above mentioned reasons.

 Make sure that there are no liquids or inflammable materials in the vicinity of the boiler. It is necessary to leave a distance of 1.0 mt between the heating device and the building material containing combustible material even though the maximum allowable temperature value of 85 °C in the rated heat capacity of the appliance is not exceeded.

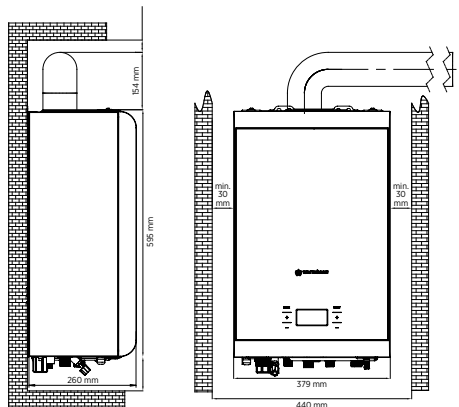
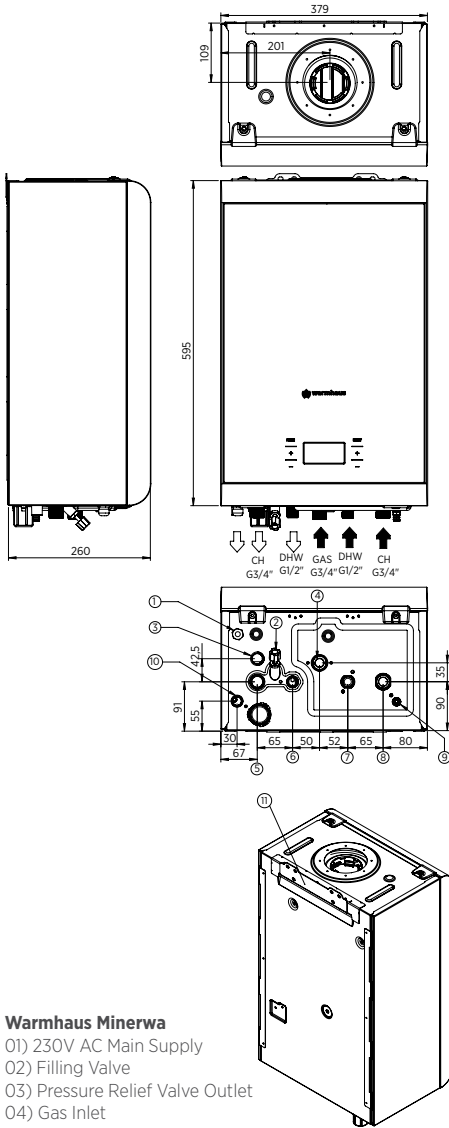

Figure 6 Boiler minimum dimensions in the cabinet
*Minimum clearances required for servicing

2.2.4. Dimensions and Connections



Warmhaus Minerwa

- 01) 230V AC Main Supply
- 02) Filling Valve
- 03) Pressure Relief Valve Outlet
- 04) Gas Inlet
- 05) Central Heating Flow (CH)
- 06) Domestic Hot Water Outlet (DHW)
- 07) Domestic Hot Water Inlet (DHW)
- 08) Central Heating Return (CH)
- 09) Drain Point
- 10) Condensate Drain
- 11) Mounting Bracket

Figure 7 Minerwa combi boiler dimensions and connections

2.2.5. Natural Gas and LPG Connection (Device Category I_{2H}, II_{2H3P})

Our products are manufactured to be operated with methane gas (G20) and L.P.G. Gas supply pipes should be equal to or higher than 3/4" G. Prior to making the gas connection, a studious internal cleaning should be made to all fuel supply installation pipe furnishings as possible wastes may distort smooth operation and reliability of the combi boiler. It should be controlled whether the gas distributed from the main line is as envisaged (see the table on the combi boiler device).

In case of having differences, an intervention should be made on the combi boiler and converted to other gas type (consult our authorized services in case of gas change). Also, in case of being inadequate, the network dynamic pressure (methane or LPG) to be used for supplying the combi boiler should be controlled regarding the impact on combi boiler power and difficulties possible for the user. Ensure the correctness of gas valve connection. Flammable gas supply pipe should be able to supply correct adequate gas amount to the boiler when the combi boiler is at full power and be projected and sized according to local gas company specification and instructions in order to guarantee the device efficiency. Connection system should comply with legal regulations.

2.2.6. Flammable Gas Quality

The combi boiler is designed to be used with pure fuel not containing any foreign substances; therefore, required filter systems must be available in the gas supply line (for ensuring purification of the fuel).

2.2.7. In Case of Using LPG Tank

For heat requirements over 24 kW, LPG tank usage is recommended instead of LPG bottle. New LPG stock tanks may contain settled gas residues (nitrogen) and this pauperises the mixture assigned to that device and cause abnormal operations.

- Various alloy layers may be formed during stocking LPG gas in tanks depending on mixture compositions. That causes a change in heating power of mixture assigned to the device and changes efficiency of the device.

2.2.8. In Case of Using Bottled Gas

- 300 mmH₂O pressurized hood should be used for LPG.
- 500 mmH₂O hood should not be used.
- 370 mmH₂O pressurized hood should be used for Propane.
- Do not place tubes at cold places having risk of snow for preventing frost during winter months.
- Do not place tubes in hot places containing ovens, fireplaces for preventing dangers!
- Do not make connection with single tube and use LPG collector set for double, triple uses.
- The distance between the collector and tube should be maximum 125 cm.
- Copper pipe installation should not be used for distances longer than 125 cm.

- Hose connection ends should be tightened with clamp and no other tools should be used.
- Gas installation rules with use of LPG bottles and industrial tanks should comply with local standards and to be performed by expert installation teams and certified by the company undertaking the construction. In case of failing to fulfil these conditions, combi boiler shall not be commissioned by Warmhaus Authorized Services.

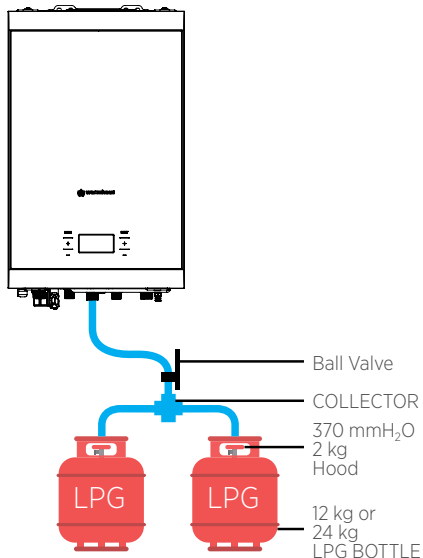



Figure 8 Combi boiler bottled gas connection

2.2.9. Filling the siphon for Condensation Line

After hanging the boiler on the wall, electrical connections, radiator lines, hot tap water connections and condensation water drainage line are completed, condensation siphon should be filled with water (Figure 9).

 Condensation line tightness should be assured. Prior to installation of the flue elbow fill the siphon in the combi boiler by pouring 1 litre water to the internal flue against the possibility of flue gas leakage possibility at first start.

Slope of condensation water hose and line must always be towards down.

Attentions For Condensate Drain:

FAILURE TO INSTALL THE CONDENSATE DISCHARGE PIPEWORK CORRECTLY WILL AFFECT THE RELIABLE OPERATION OF THE BOILER

1. Ensure the discharge of condensate complies with any national or local regulations in force.

2. The discharge pipe should be run in a proprietary drain pipe material e.g. PVC, PVC-U, ABS, PVC-C or PP.
3. Metal pipework is NOT suitable for use in condensate discharge systems.
4. Any condensate discharge pipework external to the building (or in an unheated part of it e.g. garage) must be insulated to protect against frost.
5. In all cases discharge pipe must be installed to aid disposal of the condensate. To reduce the risk of condensate being trapped, as few bends and fittings as possible should be used.
6. When discharging condensate into a soil stack or waste pipe the effects of existing plumbing must be considered. If soil pipes or waste pipes are subjected to internal pressure fluctuations when WC's are flushed or sinks emptied then back-pressure may force water out of the boiler trap and cause appliance lockout.
7. Condensate outlet shall not be modified or blocked, it shall always be downwards.

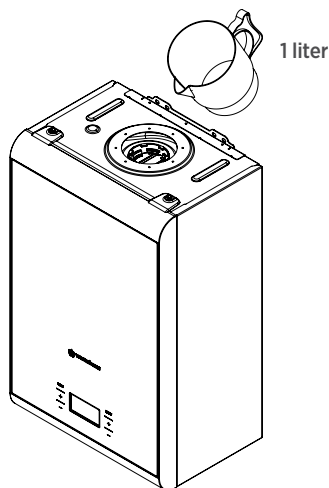

Figure 9 Filling the condensation siphon

2.2.10. Installation at Partially Protected Exteriors

Installation instructions: This combi boiler can be installed in partially protected exteriors. Partially protected place means that the combi boiler is located at places without direct exposure to atmospheric factors and precipitations (rain, snow, etc.).

Frost protection: Combi boiler is equipped with a system that prevents frost by automatically activating the pump and boiler when the internal water is lower than 5°C.

Frost protection function only depends on below given conditions:

- If the combi boiler is correctly connected to gas and electrical sources;
- If the combi boiler is supplied from gas and electricity sources (if the main switch is open) in a fixed way;
- If the combi boiler is not in failure situation due to lack of ignition;
- In order to maintain circulation of installation water, installation valves and radiator valves under the combi boiler must be open.

Under these conditions, the combi boiler is protected against frost up to -5°C environment temperature.

Lowest Temperature -5°C. In case the combi boiler is installed in an environment with a temperature lower than -5°C, and gas supply is interrupted or passed into failure due to failing to make ignition, Frost Prevention System will not be activated and frost/failure might occur in the device. Following instructions should be followed for preventing the risk of frost:

- Protecting the heating circuit against frost by using anti-freeze chemicals (special for heating circuits) from a known supplier, considering the minimum temperature needed and percentage of the antifreeze declared by the supplier

Materials used for manufacturing the combi boiler are resistant against glycol and propylene based anti-frost liquids. Follow warnings of supplier company regarding their lives and possible disposals.

Damages arising from failing to follow above mentioned issues and interruption of electricity supply shall be excluded from validity of the warranty.

In case the combi boiler is installed at places with temperature lower than 0°C (both for tap water and radiator purposes) both heating and hot water circuits must be insulated.

2.2.11. Electrical Connections

Electrical safety of the combi boiler is assured only if completely connected to an effective earthing installation that follows safety instructions in force. No earthing shall be made from the neutral line on the socket for places not having earthing! It is dangerous and unacceptable to use gas and water connection pipes for earthing.

WARMHAUS A.Ş. cannot be held as responsible for any damages and losses on individuals or commodities arising from failing to provide earth connection of the combi boiler and electrical connections not being made by a competent electrician in accordance with directives and standards in force.

Also, ensure that the electricity installation complies with the maximum power to be supplied as indicated in technical specifications label on the combi boiler. Combi boiler is given with "X" type socketless special power source cables. "Warmhaus combi boiler has an IPX5D protection level. Power supply cable should be connected by relying on earth

connection and L-N poles in a 230 V ±10%; -15 50Hz grid, high voltage category 3rd class multiple pole disconnector should be envisaged on the same grid. Always contact Authorized Warmhaus Service for replacement of the cable.



Power supply cable should follow the defined route. In case fuses on the adjustment card are replaced, please use 2A or 3,15A speed type fuses. In order to feed the device from the general electricity grid, adapter, multiple sockets and extension cables are not allowed to be used.

2.2.12. Optional Controls: Room Thermostat, Outside Sensor and Others

Room thermostat, Outside Temperature Sensor, etc. control devices must be connected to Warmhaus combi boiler devices by the authorized service personnel; in case connections are performed by unauthorized persons, combi boiler warranty shall be void.



Room thermostat, Outside Temperature Sensor, etc. control devices are provided as optional accessories for Warmhaus combi boilers and they must be Warmhaus approved.

Please follow Installation & User Manual for installation of Outside Temperature Sensor.

This sensor can be directly connected to electrical installation of the combi boiler, and it automatically reduces the maximum central heating flow temperature in the installation when exterior weather temperature rises for enabling functioning according to outside temperature changes. Outside Temperature Sensor is activated when connected as independent from the used room thermostat typology and functions as common with room thermostats. The relation between central heating flow temperature and exterior weather temperature is defined according to curves in the diagram with regards to the central heating set temperature.

Electrical connection of the Outside weather temperature Sensor shall be made to the terminals matching the 2 white cables (Figure 10).

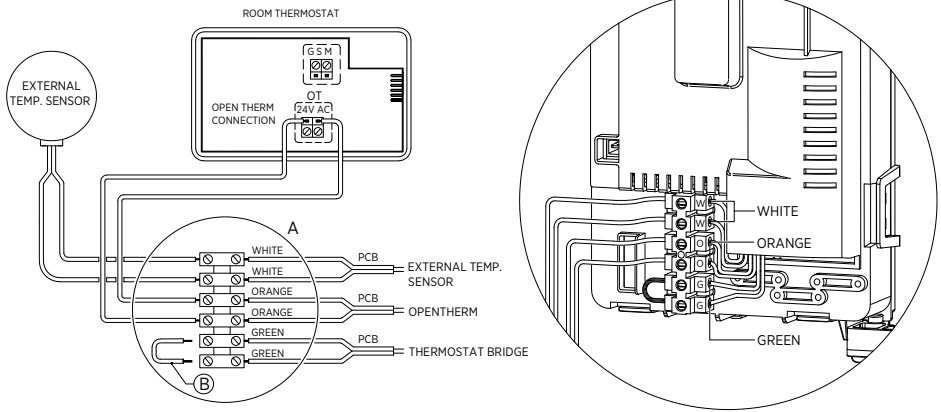

WARNING: REMOVE THE BRIDGE WIRE FROM THE ROOM THERMOSTAT / TIMER TERMINAL (B) WHEN THE TIMER OR OPENTHERM ROOM THERMOSTAT CONNECTED THE BOILER.

Figure 10 Combi boiler room thermostat and Outside Temperature Sensor connections

COMBI BOILER CONTROL ACCESSORIES



WT-RF03 Large Screen, Modulated, Weekly Program Scheduled, Wireless room thermostat
Product code: 153.11.660.600022



RC07 Modulated, Weekly Program Scheduled, Cable room thermostat
Product code: 153.11.660.600020



WT-08 Large Screen, Modulated, Weekly Program Scheduled, Cable room thermostat
Product code: 153.11.660.600021



WDHS-01 External Weather Temperature Sensor
Product code: 153.11.660.600001

Instruction for Installation:

Installation of the appliance shall be carried out only by Warmhaus Authorized Service. The dual cable required for installation shall be provided by the dealer/customer.



Room thermostat shall be mounted 1,25 to 1,5 m above the ground.



Room thermostat shall be minimum 30 cm away from any doors or windows allowing airflows.

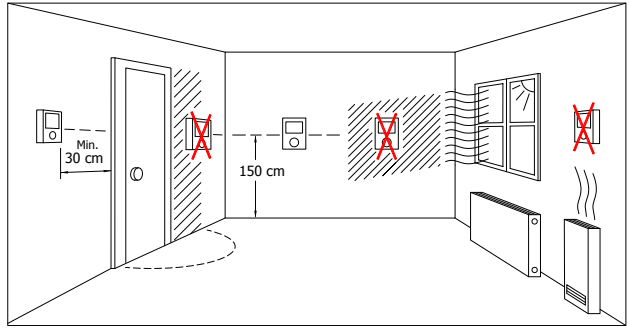

Figure 11 Position of room thermostat

2.3. HYDRAULIC INSTALLATION RULES

2.3.1. Radiator and DHW Installations

Radiator and ground heating installation should be constructed in accordance with legislation in force, technical specifications and heat loss calculation. Radiator type and amount and ground heating installation pipe amount should comply with the heat loss calculation.

- Radiator installation should be designed as resisting to at least 6 bars.
- If the city grid pressure is higher than 6,5 bars, pressure reducer must be installed.
- It is recommended to construct the radiator installation as double line and without using bends and joints as much as possible.
- Strainer filter must be installed in radiator return and tap water (city grid) input line.
- For example; as the radiator cycle's 7 litres expansion (25 kW) tank (1.0 bar) can support maximum (75 °C in radiator system) 75 litre and (55°C in ground heating system) 100 litre installation water expansion, additional expansion tank should be used for larger installation volumes. 150 litre installation water expansion, additional expansion tank should be used for larger installation volumes.
- If the room thermostat and thermostatic radiator valve shall be used together; thermostatic valve should not be installed in radiators in the place where room thermostat is available!
- Cross connection must be made for efficient functioning in radiators longer than 1,5 m.
- Covers should be used for radiator and hot tap water wall passages and fixed with wall clamps for preventing slopes in expansions due to heating.
- Combi boiler can function at minimum 0,5 bar tap water pressure and that corresponds to a very low flow rate and therefore, it is quite probable that the requested tap water temperature can not be provided. For this reason, tap water line should be installed at shortest distance with pipe having at least ½" internal diameter and by using bends as low as possible. At

least 1 bar pressurized grid input water should be supplied for acquiring the comfort requested in the hot tap water. Hydrophore should be used if required.

- Prior to filling the radiator installation, it must be flushed and all wastes must be cleaned!



Warning: In order to prevent invalidity of device warranty prior to making combi boiler connections, clean residues likely to exist in main heat exchangers (pipes, heater assembly, etc.) via dissolvent or equal substances, otherwise they will negatively affect functioning of the combi boiler. In order to prevent lime scales in the heating circuit and therefore faulty operation of installation, follow rules envisaged by standards regarding domestic tap water and radiator installations.



Warning: It is recommended to install a Anti-Lime Kit for preventing occurrence of lime scales at places where water hardness is higher than 25 French degree in order to protect service life and efficiency of the hot tap water heat exchanger.

2.3.2. Filling/Emptying Radiator Installation

To fill the radiator circuit of the combi boiler, make sure that the pressure in the heating line reaches 1-1.5 bar by turning the Fill Valve clockwise indicated by symbol 2 in Figure 7.

After installation close the Filling Tap by rotating clockwise and discharge air of radiators via air discharge valves.

Combi boiler safety valve discharge should be connected to a discharge funnel. Otherwise, safety valve shall be activated and manufacturer shall not be responsible due to water discharge to the place of device.

Discharging the Condensation Water

For discharging the condensation water produced by the device, it should be connected to waste water grid via at least Ø 19 mm pipes resistant to acidic condensation waters. Connection of the device with waste water

grid should be made as preventing frost of the liquid contained in the connection installation. Prior to starting the device, ensure that the condensation water is correctly discharged; then verify that the siphon is filled

through condensation at first start (parag. 2.2.10). Also, instructions in force, national and local arrangements should be taken into consideration for discharge of waste waters.

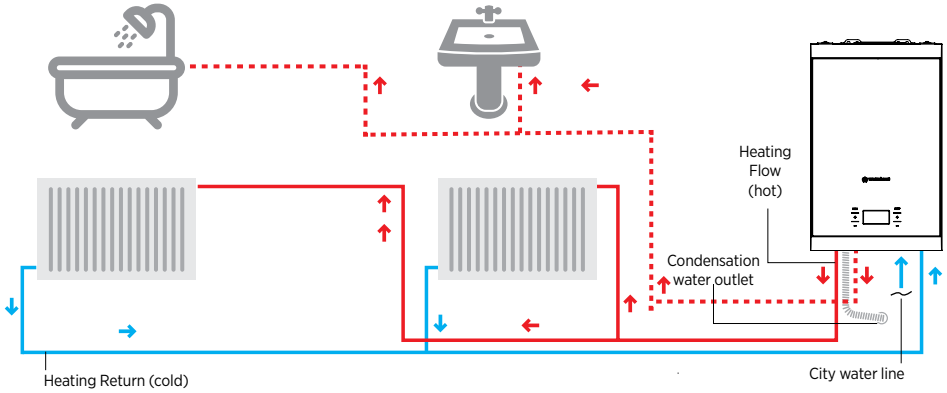

Figure 12 Combi boiler general installation scheme

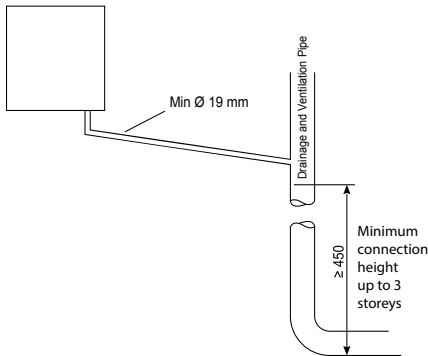

Figure 13 Connection of the Condensate Water Drainage Pipe to Internal Drainage and Ventilation Pipe

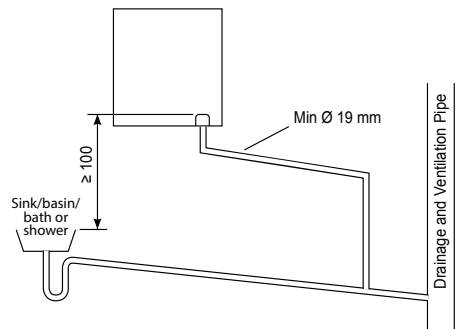

Figure 14 Connection of Condensate Water Drainage Pipe at Indoor Bathroom Drainage Lower Level

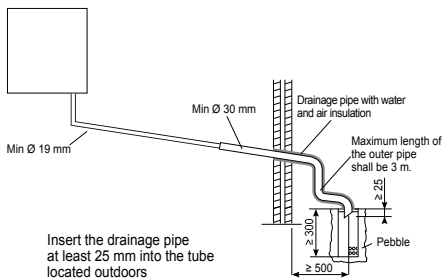

Figure 15 Outside Connection of Condensate Water Drainage Pipe

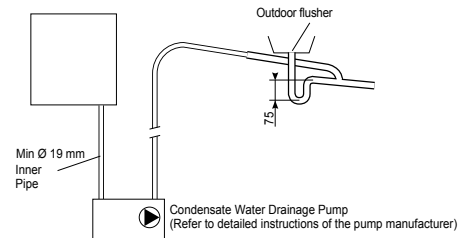

Figure 16 Typical Connection Method of a Condensate Water Drainage Pipe (refer to detailed instructions of the pump manufacturer)

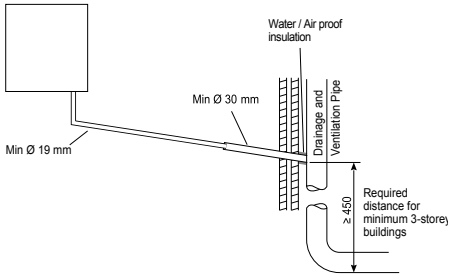

Figure 17 Connection of Condensate Drainage to Drainage and Ventilation Pipe

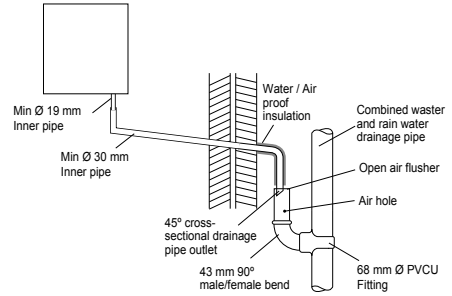

Figure 18 Connection of Condensate Drainage to Rain Water Drainage

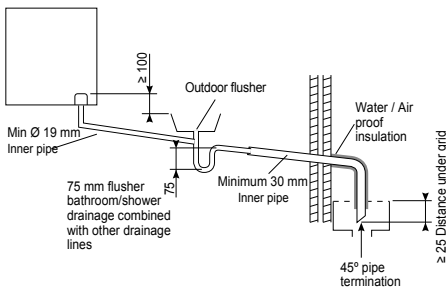

Figure 19 Connection of Condensate Drainage to Rain Drainage Line through Sink, Bathtub or Shower Drainage Pipe

2.3.3. Circulation Pump

MINERWA is equipped with a pump having controlled by an external signal PWM (i=feedback signal), the main PCB of combi boiler sends a PWM signal as an actuating variable to the pump. It should be controlled that the pump ensures required flow rate depending on the critic line pressure loss (see figure 21 and 22)..

- Ensure that no electricity interruption is available at your home.
- Ensure that no grid water interruption is available at your home.
- Ensure that water is supplied to radiator installation and 1,2 - 1,5 bar pressure is seen in the combi boiler manometer.

2.3.4. Controls for Initial Operation of Combi Boiler

In order to keep the combi boiler within scope of warranty, first start must be performed by Warmhaus Authorized Service. Below given initial preparations should be performed prior to authorized service appointment request:

- Gas opening approval certificate should be taken from the local gas company for your gas line,
- Combi boiler electricity connection should be made via 2 or 3 Amps fuse.



Figure 20 Pump with Automatic Air Vent Valve and modulation.

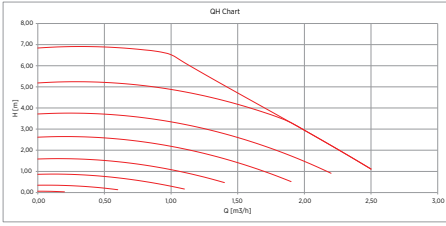

Figure 21 Minerwa 25 pump Flow Rate / Pressure graphic

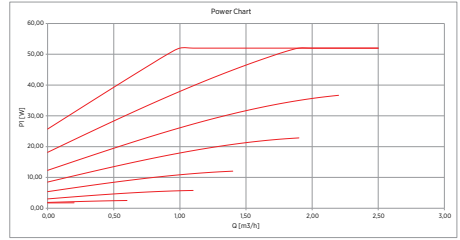

Figure 22 Minerwa 25 Pump Flow Rate / Power graphic

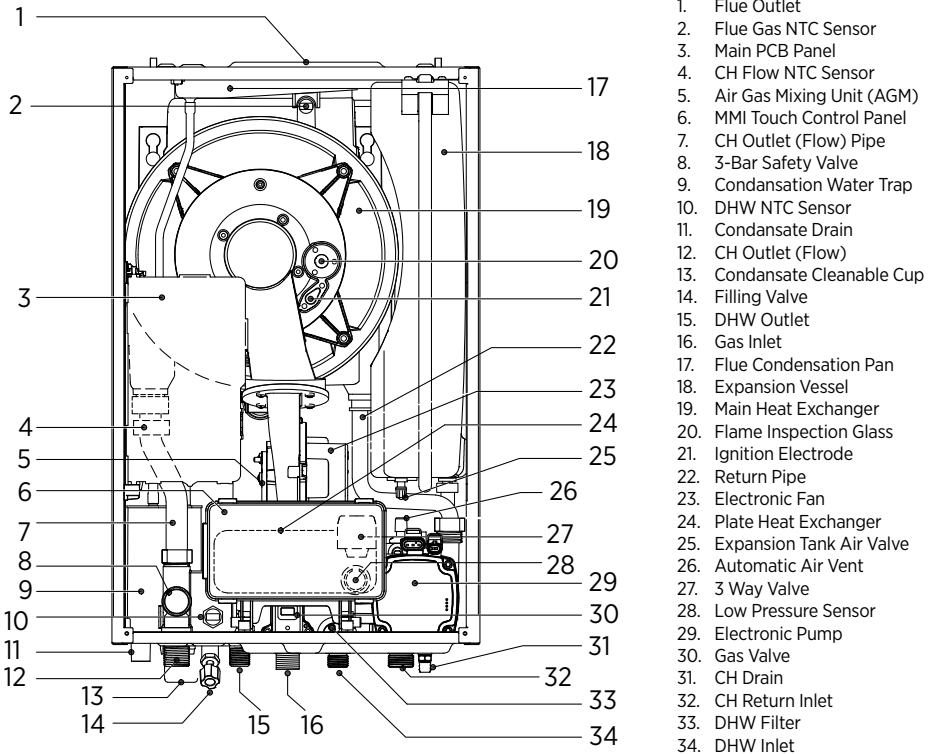



Figure 23 Components of Combi Boiler

2.4. COMBI BOILER FLUE CONNECTIONS

2.4.1. Exhaust Gas Flue Pipe Set and Accessories Connection

 Flue accessory sets to be used in exhaust gas installation of hermetic combi boiler should be original Warmhaus flue sets and they should be used by considering measurements and restrictions given in installation instructions.

 In case of using exhaust gas pipe and/or accessories other than Warmhaus original exhaust gas flue pipes and accessories, combi boiler shall not be commissioned by the Authorized Service and thus, no warranty is given!

Warmhaus provides different solutions for placing exhaust gas discharge and air suction pipes in addition to the combi and combi shall not be operated without them.

Combi should only be installed with original Warmhaus air

suction and exhaust gas discharge device made of plastic material. Plastic channels cannot be installed without suitable protection against UV and weather conditions to distances over 40 cm and exteriors. Every pipe is defined with an explanatory and discriminative  Warmhaus mark mentioned in remarks.



See Figure 24.

Flue should be installed in accordance with national and local directives.



Figure 24 Warmhaus logo is available on the flue bend.

2.4.2. BOILER FLUE CONNECTION TYPES

 Air
 Exhaust Gas

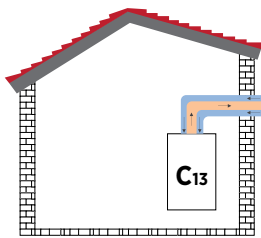

Discharge with concentric flue connection

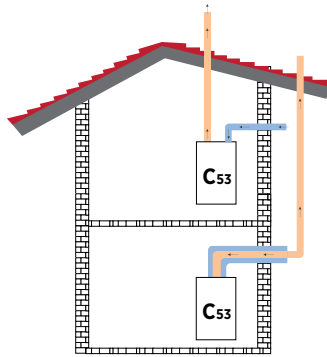

Exhaust gas discharge and fresh air intake with concentric flue kit and split flue kits

For room sealed appliances of the type C5 boilers

Attention: The terminals for the supply of combustion air and for the evacuation of combustion products shall not be installed on opposite walls of the building.

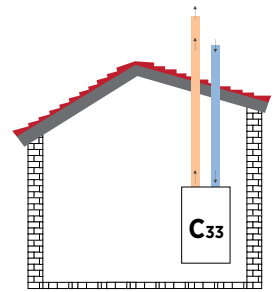

Exhaust Gas Discharge Fresh Air Intake with Split Flue Sets

The terminal outlets from separate combustion and air supply circuits shall fit inside a square of 50 cm and that the distance between the planes of the two orifices shall be less than 50 cm.

Figure 25 Hermetic (Concentric) and Flue (Split-Flue type)

Figure 26 Hermetic concentric and vertical split flue connection.

Figure 27 Vertical Type Hermetic Use with Split Flue Set

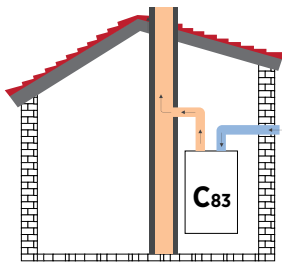

Discharge to building chimney and fresh air intake with split flue connection

For room sealed appliances of the type C8 boilers

- overheat combustion products temperature; $< 105\text{ C}^\circ$
- G20 : CO₂-content; 9.00 % (tolerance $+\%0,5 / -0,5\%$); G30 / G31: CO₂-content; 10.00 % (tolerance $+\%0,5 / -0,5\%$)
- characteristics of the chimney to which the boiler may be connected, according to fig 13.
- condensate flow into the appliance is not allowed.

Figure 28 Hermetic vertical split flue connection.

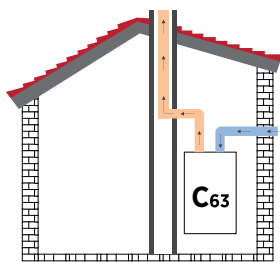

Exhaust gas discharge through the building chimney and fresh intake from outside with split flue sets

For room sealed appliances of the type C6 boilers

overheat combustion products temperature for flue; $< 105\text{ C}^\circ$ G20 : CO₂ content at nominal operating conditions; 9.00 % (tolerance : $+\%0,5 / -0,5\%$) G30 / G31 : CO₂ content; 10.00 % (tolerance : $+\%0,5 / -0,5\%$) maximum allowable draught and maximum allowable pressure difference between combustion air inlet and flue gas outlet (including wind pressures); 120 Pa. characteristics and the applications of the duct system to which the boiler can be connected; condensate flow into the appliance is not allowed. Maximum allowable temperature of combustion air; 40 C° maximum allowable recirculation rate of 10 % under wind conditions.

Attention: The terminals for the supply of combustion air and for the evacuation of combustion products shall not be installed on opposite walls of the building.

Figure 29 Building chimney connection with hermetic split flue

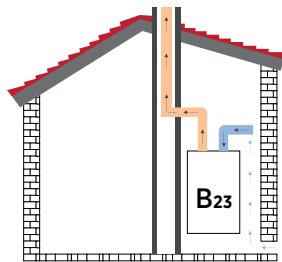

Exhaust gas discharge through the building chimney and fresh intake from the building chimney with split flue sets

Figure 30 Exhaust gas discharge through the building chimney and fresh intake from the building chimney with split flue sets

Flue outlets must not be subject to any blockage and must not interfere with any other flue outlet. If the output pipe passes 1000 mm nearby of a plastic or painted groove or 500 mm of painted fringes, an aluminium shield with at least 1000 mm length should be placed below the groove or fringe. Output pipe should be at least 2 m over surfaces that may be reached by individuals.

Under certain weather conditions, output pipe may emit water vapour; installation should not be performed at places where this vapour may cause discomfort.

Exhaust gases should be prevented from entering flue ventilation spaces.

Flue system of combi boiler may be installed from inside the room without requiring intervention from the external wall. For that reason, a housing should be installed in the wall for lining the internal surface of channel wherein the output pipe passes through, particularly for thick walls.

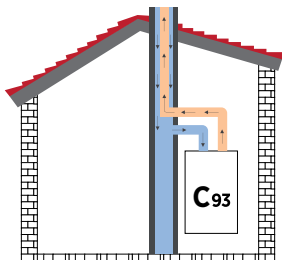

Attention: The minimum usable diameter must not be under 80 mm or equivalent for the vertical duct supplying the combustion air.

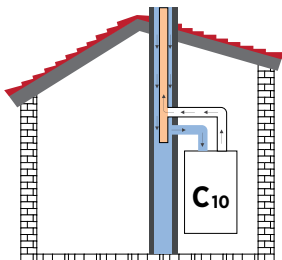

Attention:

- nominal working combustion product temperature : $> 70^{\circ}\text{C}$ max conditions
- overheat combustion products temperature : 105°C
- the minimum length of the specified connecting ducts; 1 mt / maximum length of the specified connecting ducts; 10 mt
- For size/shape of the end of the fitting please refer 2.2.14. Installation with Vertical Flue Sets page 13, Fig.26.
- Please re adjust TsP Paramater P22 = Flues gas pipe length (value 1 = 1 meter) according to actual flue lenght
- Its MUST to use NON RETURN valve ON the flue gas system.
- non-return valve function has to be checked annually by authorised service.

Information for the design of the common duct system for a type C(10) boiler

- The boiler is designed to become connected to a common duct system that is designed to operate where the static pressure in the common flue duct might exceed the static pressure in the common air duct by 25 Pa under the condition that n-1 boilers are running at maximum nominal heat input ($Q_{n,max}$) and 1 boiler at the minimum heat input allowed by the controls
- combustion product mass flow rate at maximum nominal heat input are given technical table.
- combustion product mass flow rate at minimum heat input allowed by the controls are given technical table.
- G20 : CO2 or O2 content of the combustion products at nominal operating conditions 9% (+0,5/-0,5)
G30 / G31: CO2-content; 10.00% (tolerance : +%0,5 / -0,5 %)
- minimum allowable pressure difference between combustion product outlet and air inlet shall be declared as -200 Pa (including -100 Pa wind pressure).

General for connection of a type C(10) boiler to a common duct system

Characteristics and the applications of the common duct system to which the boiler can be connected, with at least the following information:

- the flue duct system shall be CE marked and comply with EN 15502 standart 12.2.1.4.111.2;
- nominal combustion products temperature for dimensioning the common duct system shall be declared as 25°C ;
- the combustion product mass flow rate at maximum heat input shall be specified for every connection point; the terminal of the common duct shall be designed to induce a draft;
- condensate flow into the boiler is allowed;
- maximum allowable recirculation rate of 10 % under wind conditions;
- the maximum allowable pressure difference between combustion product inlet and air outlet of the common duct system shall not be exceeded when n-1 boilers are running at maximum nominal heat input ($Q_{n,max}$) and 1 boiler at the minimum heat input allowed by the controls;
- the common flue duct shall be appropriate for an overpressure of at least 200 Pa;
- the duct system shall not include a draft diverter.

Warning: the boiler if it is installed as a C (10) boiler and IF / when the boiler is disconnected the air outlet and the combustion product inlet openings shall be closed and checked on tightness.

Figure 31 Exhaust gas discharge through the building chimney and fresh intake from the building chimney with split flue sets

2.4.3. Peripheral Distances of Flue Output Connections

In order to position the flue set output pipe

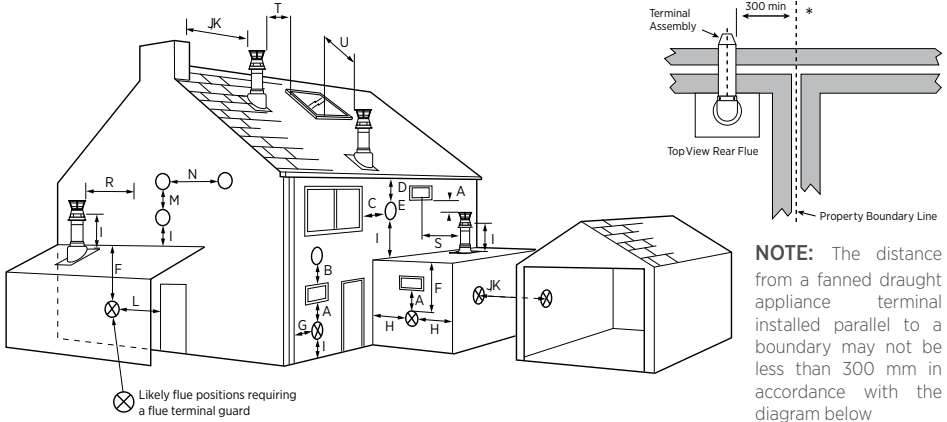

Figure 32 Environmental locations of flue

	Terminal Position with Minimum Distance	(mm)
A ¹	Directly below an opening, air brick, opening windows, etc.	300
B ¹	Above an opening, air brick, opening window etc.	300
C ¹	Horizontally to an opening, air brick, opening window etc.	300
D ²	Below gutters, soil pipes or drain pipes.	25 (75)
E ²	Below eaves.	25 (200)
F ²	Below balconies or car port roof.	25 (200)
G ²	From a vertical drain pipe or soil pipe.	25 (150)
H ²	From an internal or external corner.	25 (300)
I	Above ground, roof or balcony level.	300
J	From a surface or boundary line facing a terminal.	600

	Terminal Position with Minimum Distance	(mm)
K	From a terminal facing a terminal (Horizontal flue). From a terminal facing a terminal (Vertical flue).	1200 600
L	From an opening in carport (e.g. door, window) into the dwelling.	1200
M	Vertically from a terminal on the same wall.	1500
N	Horizontally from a terminal on the same wall.	300
R	From adjacent wall to flue (vertical only).	300
S	From an adjacent opening window (vertical only).	1000
T	Adjacent to windows or openings on pitched and flat roofs	600
U	Below windows or openings on pitched roofs	2000

- 1 In addition, the terminal should be no nearer than 150 mm to an opening in the building fabric formed for the purpose of accommodating a built-in element such as a window frame.
- 2 Only ONE 25mm clearance is allowed per installation. If one of the dimensions D, E, F, G or H is 25mm then the remainder MUST be as shown in brackets, in accordance with B.S.5440-1.

2.4.4. Installation with Horizontal Flue Sets

Connecting Horizontal Concentric Flue Set to the Combi Boiler, (original diameter DN 60/100 mm)

Since your combi boiler is hermetic model, it takes the used air from exterior and discharges exhaust gases created as

the result of burning through the same flue group. In order to prevent emission of excessively harmful exhaust gases, flue usage and installation is very important, therefore warnings should be taken into consideration when flue connections are being performed.

- Make required flue selection for the flue connection to be made external and installation place of the combi boiler. If the standard flue set is not adequate,

please select most suitable elements from our list of connection accessories considering warnings given in our user's guide.

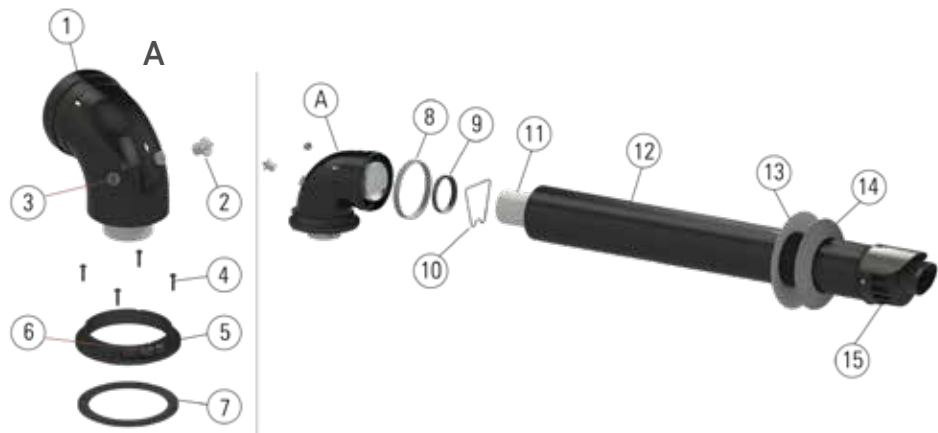

- 90° elbow
- Inspection Cap (Gas)
- Inspection Cap (Fresh Air)
- Screws
- Flange Gasket

- Flange Gasket Screw
- Neoprene Gasket
- Ø100 Sealing Gasket
- Ø60 Sealing Gasket
- Centralizer

- Internal Flue Pipe
- Internal Flue Pipe
- Internal Wall Plate
- External Wall Plate
- Grill

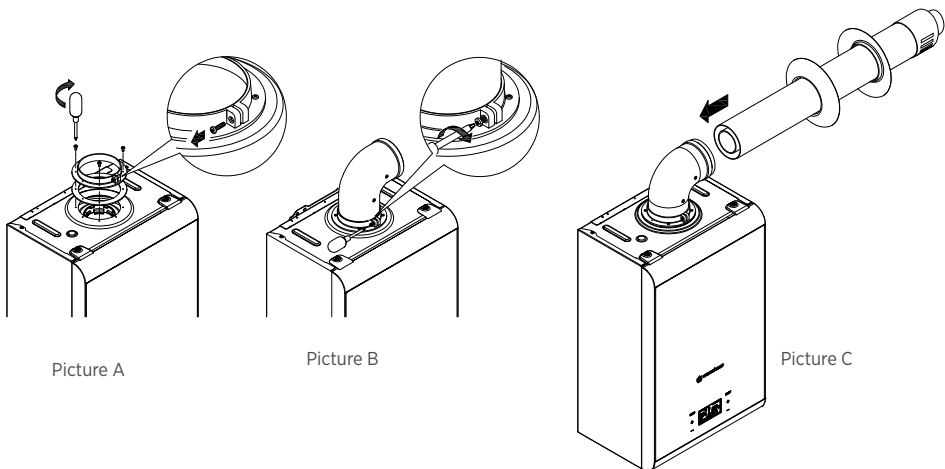

Figure 33 Hermetic combi boiler concentric flue set.

- Loosen the Flange Gasket Screw (Fig.33_6) and remove it from the elbow (Fig.33_1)
- Put the Neoprene Sealing Gasket (Fig.33_7) under the flange and secure it with 4 screws (Fig.33_6 and see Picture A)
- Place the flue elbow (90°) (Fig.33_1) press down and tighten the screw (Fig.33_6) to secure the flue elbow (see picture B)
- Fit the outer and inner wall flanges (Fig.33_13-14) on the terminal pipe (Fig.33_12)
- Connect flue to the boiler, positioning the seals correctly (picture C). Seal the flue into the wall with silicone or sand + cement and cover with Wall Seals provided.
- It is important that the flue terminal must have an horizontal sloping not less than 1,5 deg. (25 mm per meter) towards the boiler.

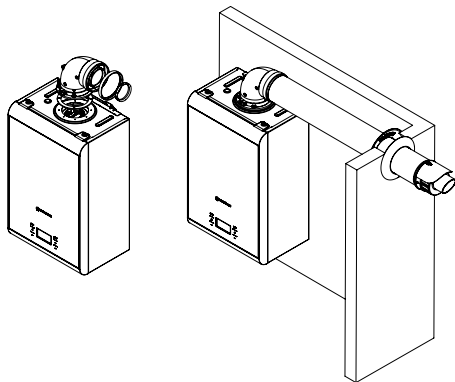
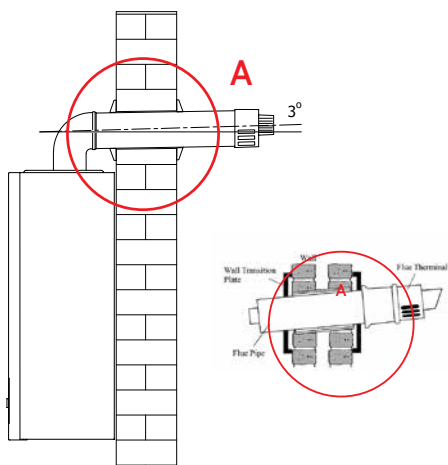

Figure 34
Installation of flue set pieces

Figure 35 Hermetic combi boiler concentric flue wall output.



! During installation of horizontal pipes, the pipe slope should be kept at 3% upwards as minimum and at every 3 meter holder clamps should be used with dowels.

Figure 36 Condensing combi boiler flue training

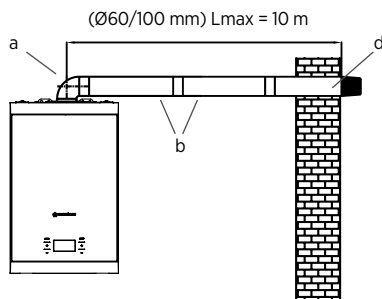
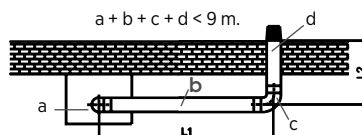

Figure 37 I. Single 90° bended sample flue installation



- a- Standard Flue Set Elbow (90°)
- b- Flue Extension Pipe
- c- Additional 90° Elbow
- d- Standard Flue Set Pipe

Figure 38 II. Two 90° elbow sample flue installations

Total length of hermetic flue set should not exceed 10 m with single elbow horizontally. Also, this total length reduces by 1 m with every 90° elbows or two 45° elbows. Maximum 3 pieces of 90° elbow can be used.

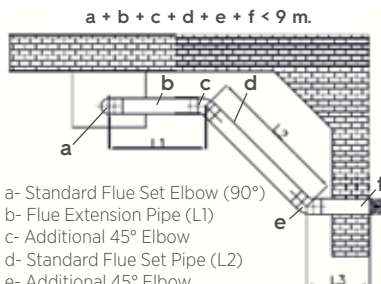

- a- Standard Flue Set Elbow (90°)
- b- Flue Extension Pipe (L1)
- c- Additional 45° Elbow
- d- Standard Flue Set Pipe (L2)
- e- Additional 45° Elbow
- f- Standard Flue Set Pipe (L3)

Figure 39 III. Single 90° and two 45° elbow sample flue installations



When it is required to shorten the discharge flue and/or extension, consider that internal pipe should protrude 5 mm when compared with the external pipe.



For security purposes, combi boiler suction / discharge flue should not be blocked even temporarily.

2.4.5. Installation with Vertical Flue Sets (Ø60/100 mm)

Your combi boiler can also be vertically connected to flat and aslope roofs via available connection accessories depending on the status of installation place. For flat connections (Ø 60/100mm) vertical flue set should not exceed 11 m.

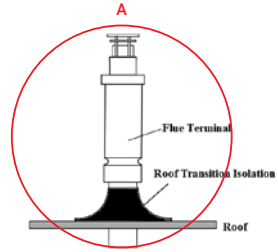
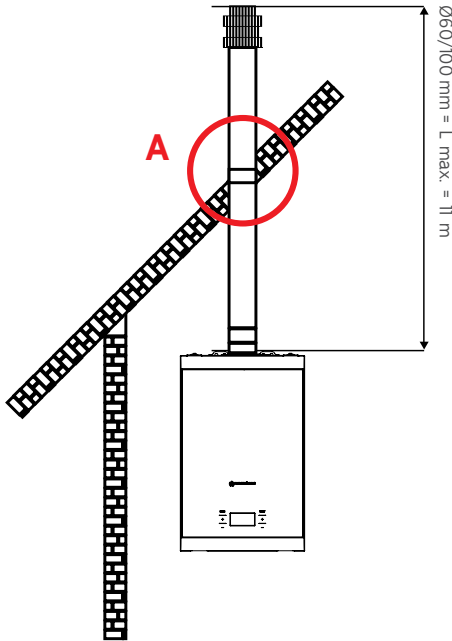

ATTENTION!

For C3 boilers the terminal outlets from separate combustion and air supply circuits shall fit inside a square of 50 cm and that the distance between the planes of the two orifices shall be less than 50 cm.

Figure 40 Vertical flue set installation

2.4.6. Twin Flue Kits Ø 80/80 Flue Type Use

This kit allows air to come in from outside the building and the fumes to exit from the chimney or flue through divided flue exhaust and air intake pipes. Combustion products are expelled from pipe (F) (in plastic, so as to resist acid condensate). Air is taken in through duct (A) for combustion (this is also in plastic). Extensions for

separator kit Ø 80/80. The maximum vertical straight length (without elbow) that can be used for Ø 80 intake and exhaust pipes is 34 metres, regardless from whether they are used for intake or exhaust. The maximum horizontal straight length (with elbow in suction and in exhaust) that can be used for Ø 80 intake and exhaust pipes is 30 metres, regardless from whether they are used

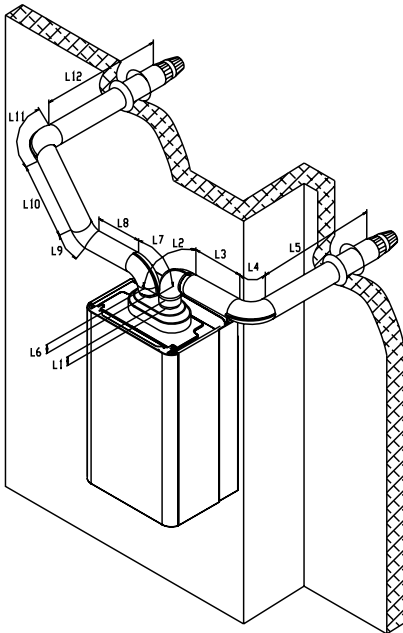

Figure 42 Hermetic flue type installation sample

Implementation

- L1 =0.5 m.
- L2 =1.0 m. (90° elbow equivalent length)
- L3 =1.5 m.
- L4 =1.0 m. (90° elbow equivalent length)
- L5 =1.5 m.
- L6 =0.5 m.
- L7 =1.0 m. (90° elbow equivalent length)
- L8 =0.5 m.
- L9 =0.5 m. (45° elbow equivalent length)
- L10 =1.5 m.
- L11 =1.0 m. (90° elbow equivalent length)
- L12 =1.5 m.

L Total =12 m. 12 m. < Lmax = 30 m.

Correct in implementation.

ATTENTION!
For CI boilers the terminal outlet from separate combustion and air supply circuits shall fit inside a square of 50 cm for boilers with a heat input up to 70 kW.



When installing a replacement boiler a new flue system is delivered with the boiler as original flue set must be used and re-using the existing boiler flue installation is strictly not acceptable

for intake or exhaust.

Design

Individual air supply and flue outlet pipes are used as standard. The material approved for this application which MUST be used are:

Termination Of The Flue And Air

The flue and air pipes may terminate independently through any external walls within the same dwelling except on opposing walls, within the maximum lengths shown in graph below. (Alternatively a vertical flue pipe termination is acceptable.)

The air pipe must have an elbow and 150 mm length of pipe directed downwards with a termination grill fitted.

The air pipe can be situated at the side or beneath the flue pipe to a minimum dimension of 140 mm (see Table.1). It must not be sited above the flue pipe.

The flue and air pipes must extend by at least 40 mm from the wall surface.

Condensing boiler emit a visible plume of water vapour from the flue terminal, this is normal. It is the responsibility of the installer to judiciously select a terminal location that does not cause a nuisance.

If either the flue or air terminal is below a height of 2 m from ground level a terminal guard must be fitted.

Note. Any vertical termination MUST have the terminals fitted and the air intake comply with the dimensions above

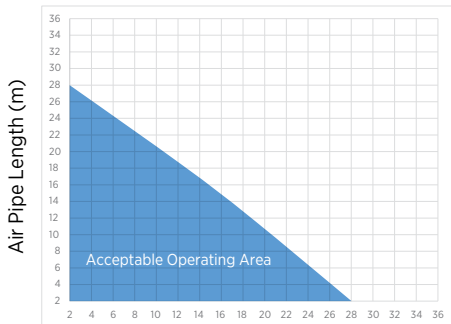
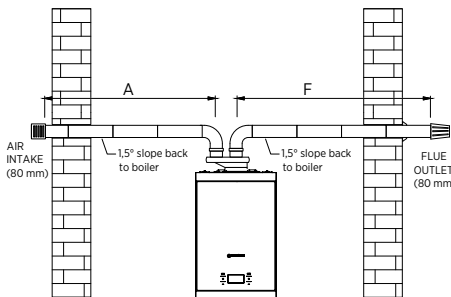

Table 1 Air Pipe and Flue Pipe Lengths Diagram



TOTAL HORIZONTAL LENGTH: $A + F = 30\text{ m}$

Figure 44 Horizontal Air-Flue Lengths

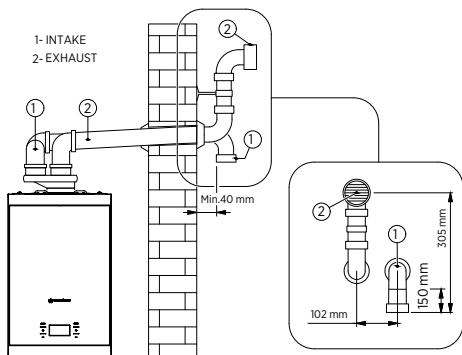
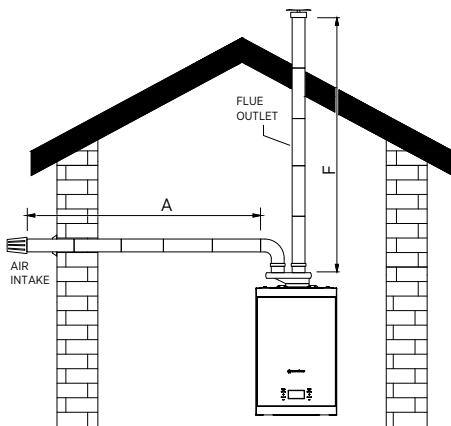

Figure 43



TOTAL VERTICAL LENGTH: $A + F = 32\text{ m}$

Figure 45 Vertical Air and Horizontal Flue Lengths

Concentric Flue Systems For Condensing Boilers (Ø60/100 mm)

	Product Name	Product Code
	(Ø60/100) Condensing Concentric Horizontal Flue Set	153.11.014.000002
	(Ø60-100) Condensing Vertical Flue Set with Adapter L=1533	153.11.660.600013
	(Ø60/100) Condensing Flue Extension L=500 mm	153.11.660.600014
	(Ø60/100) Condensing Flue Extension L=1000 mm	153.11.660.600015
	(Ø60/100) Condensing Flue Extension L=2000 mm	153.11.660.600016
	(Ø60/100) Condensing 45° Elbow	153.11.660.600017
	(Ø60/100) Condensing 90° Elbow L=170 mm	153.11.660.600018
	(Ø60/100) Condensing Vertical Adapter L=130 mm	153.11.660.600019

Twin Flue Kits For Condensing Boilers (Ø80/Ø80 mm)

153.11.660.600096 Ø80 Twin Flue Set

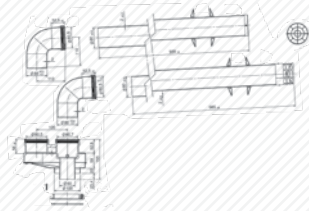

153.11.660.600102 Ø 60- Ø 80 Twin Flue Set Adapter

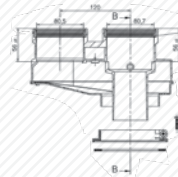

153.11.660.600091 Ø80 Condensing Twin Flue Extension Pipe
L=500 mm

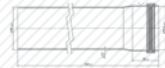

153.11.660.600092 Ø80 Condensing Twin Flue Extension Pipe
L=1000 mm



153.11.660.600093 Ø80 Condensing Twin Flue Extension Pipe
L=2000 mm



153.11.660.600094 Ø80 Twin Flue Elbow (90°)

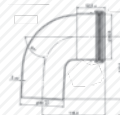

153.11.660.600095 Ø80 Twin Flue Elbow (45°)

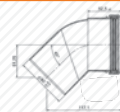

153.11.660.600099 Ø80 Interior Wall Rosette

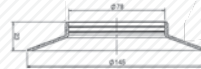

153.11.660.600098 Ø80 Exterior Wall Rosette



153.11.660.600100 Ø80 Flue Vertical Outlet Adapter with
Condensate Trap



153.11.660.600097 Ø80 Vertical Flue Kit



Plume Displacement Kits Ø60 mm

	Product Name	Specification	Product Code
	Plume Displacement Terminal Kit	With 1 m Extension and Two Brackets	153.11.660.6000 31
	Plume Displacement Kit Elbow	90°	153.11.660.6000 32
	Plume Displacement Kit Elbow	45°	153.11.660.6000 33
	Plume Terminal		153.11.660.6000 34
	Clamp Pack		153.11.660.6000 35
	Plume Displacement Kit Extension and Brackets	1000 mm	153.11.660.6000 36

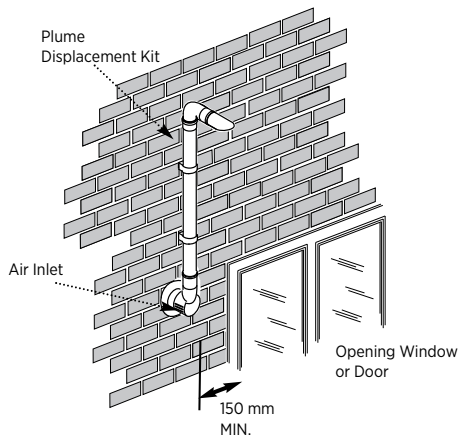

Figure 46 Installation Position of Plume Displacement Set to Window or Door

IMPORTANT:

- Under car ports we recommend the use of the plume displacement kit.
- The terminal position must ensure the safe and nuisance - free dispersal of combustion products.

IMPORTANT:

If fitting a Plume Displacement Flue Kit, the air inlet must be a minimum of 150mm from any opening windows or doors)

2.4.7. Recommendations of Plume Kit Installation

NOTE: Due to the nature of the boiler a plume of water vapour will be discharged from the flue. This should be taken into account when siting the flue terminal.

1. The following guidelines indicate the general requirements for siting balanced flue terminals. For GB recommendations are given in BS 5440 Pt 1. For IE recommendations are given in the current edition of I.S. 813 "Domestic Gas Installations".
2. If the terminal discharges onto a pathway or passageway, check that combustion products will not cause a nuisance and that the terminal will not obstruct the passageway.
3. If a terminal is less than 2 metres above a balcony, above ground or above a flat roof to which people have access, then a suitable terminal guard must be provided.
4. *Reduction to the boundary is possible down to 25 mm but the Plume Displacement Kit Bend (45°) (part no. 153.11.660.6000 33) must be fitted.

3. USER'S SECTION

3.1. GENERAL WARNINGS FOR USER

3.1.1. Use of Combi Boiler

If a gas odour is available in the environment, close home entrance line and gas valves of your combi boiler or close the LPG tank valve or bottle valve if bulk gas is used. Do not shut on-off electricity buttons and do not do

Control Panel of Minerwa Model Combi Boiler

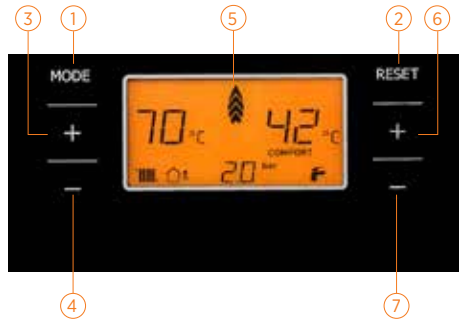

Figure 47 Control panel of Minerwa 25 Combi Boiler

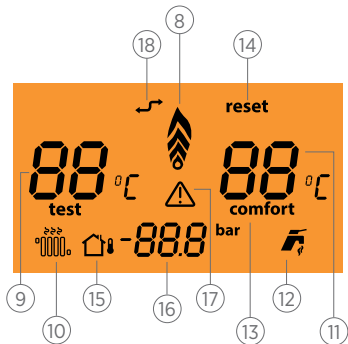

Figure 48 Control Panel with Touch Screen of Minerwa 25 Combi Boiler

anything those may create sparks. Call the gas company or Authorized Service. (See 1.3 GAS LEAKAGES, Page 6)

First start should be performed by the Warmhaus Authorized Service for your safety and preventing void warranty scope. Our Authorized Service will give you required information about use of the boiler after

performing initial controls and starting for the first time.

Perform below given controls prior to use:

- Ensure that radiator/heating system, tap water and gas valves located under your combi boiler are open, the radiator installation pressure is between 1 - 1,5 bar on the manometer located under the combi boiler and system air is discharged,
- Gas is available in your gas line (you can control by igniting one of your gas ovens),
- Combi boiler electrical fuse is open,
- No flammable materials and products are available near to the combi boiler,
- Exhaust gas flue set output is not blocked,
- If a room thermostat or control device is connected, ensure that it is at ON position.

If you will shut-off the combi boiler for a long period, perform below written operations:

- Discharge the radiator installation water not containing anti-freeze,
- Close combi boiler electrical fuse, gas valve, radiator and tap water valves!

If you will shut-off the combi boiler for a short period, perform below written operations:

- Do not close combi boiler electrical fuse, gas valve, radiator and tap water valves!
- Leave the combi boiler at Summer position and activate its Frost Protection function,

Shut-off the combi boiler during maintenance and repair operations to be performed around exhaust gas discharge flues. After operations are completed, have the combi boiler controlled by Warmhaus Authorized Service before using it again.

Follow below given main rules:

- Do not clean external frame of combi boiler while is functioning and do not use easily flammable materials.
 - Do not hold the combi boiler with wet hands or feet; also without shoes and with bare feet.
 - Do not pick electricity cables.
 - In case cables are damaged, shut-off the boiler and fuse switches and do not use the combi boiler.
 - Electrical cables of combi boiler and its accessories should be replaced by the Authorized Service.
 - Do not expose the combi boiler to direct vapour those may arise from cooking places.
 - Prevent use of combi boiler by children and inexperienced persons. Touch-Buttons & Screen Symbols
1. **MODE**, selection button.
 2. **RESET** button.
 3. Radiator (CH) water temperature increasing button.
 4. Radiator (CH) temperature decreasing button.

5. Digital display screen
6. Domestic Hot Water temperature increasing button.
7. Domestic Hot Water temperature decreasing button.
8. Flame modulation indicator
9. Radiator (CH) water actual temperature
10. Radiator (CH) mode operating indicator
11. Domestic Hot Water actual temperature
12. Domestic Hot Water operating indicator
13. Comfort mode operation
14. Failure status **RESET** requirement.
15. External Weather Temperature Sensor connection
16. Digital manometer (Radiator pressure 1,3 bar warning symbol; E02 failure code is indicated if the pressure is



e)When the combi boiler is started for the first time, screen displays 'n6'. The thermostat connection number (for instance 25) indicating kW power of the device



Then, OFF is displayed,



and screenlight is closed. Now, combi boiler is at STANDBY position. The temperature value when electricity is supplied to the device is the temperature value of water in the heating circuit.

The temperature value displayed on the digital screen has a $\pm 3^{\circ}\text{C}$ tolerance depending on environmental conditions not arising from the combi boiler. Screen of Minerwa 25 combi boiler model consist of amber coloured backlight LCD screen and 6 touch sensitive buttons : RESET, MODE, CH (+), CH (-), DHW (+), DHW (-).

RESET: It is used for re-starting the combi boiler and Hold the MODE button for switching on the combi boiler when **OFF** is available on the screen.



Hold the MODE button for switching on the combi boiler when **OFF** is available on the screen.

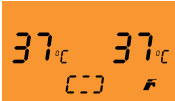

A cycle appears on the display.



Release the button when cycle is completed.



In such case, combi boiler initially gets into Radiator position, its symbol flashes on the left bottom corner of screen and tap symbol is seen at right bottom corner of the screen and actual heating circuit pressure is located at lower middle section of the screen and also actual heating circuit temperature is seen on the screen at the same time and screen light is turned off.

When combi boiler is started, flame modulation symbol is seen at the middle section of the screen. At that position, you can increase and decrease the temperature with CH temperature adjustment buttons (see. Figure 40) (3) between 35 – 80 °C, screen lights when buttons are pressed and °C symbol flashes besides the CH temperature value.



{If you have a ground heating system, as our Authorized Service adjust your combi for “Low Temperature Operation”, maximum temperature shall be limited with the Radiator (CH) temperature adjustment button (3) (e.g. maximum 50 °C)}.



Domestic Hot Water Adjustment at Winter Position; You can adjust the hot tap water temperature value between 35 – 60 °C with (6) and (7) numbered buttons under the RESET button. Screen lights during temperature change, °C symbol flashes besides the DHW temperature value. Screen light turns off after adjustment.

eliminating the failure in case of combi boiler failure.

MODE: It is used for switching between operating modes: Winter / Summer / OFF.

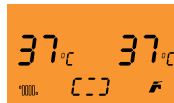

In order to switch to Summer, hold **MODE** button and release the button after completion of cycle on the screen. At that position, symbol flashes at right bottom corner of the screen and actual DHW temperature will be seen on the screen and screen light will turn off.

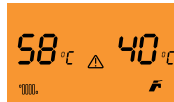

In this mode, you can adjust the Domestic Hot Water temperature between 35 –60 °C with (6) and (7) numbered buttons below the RESET button.

Screen lights during temperature change, °C symbol flashes besides the DHW temperature value. Adjustment value is confirmed after screen light turned off following the adjustment.

Shutting off the Combi Boiler

To bring the combi boiler to OFF position while it is in SUMMER position;



When the **MODE** button is hold, while screen light is on after the cycle **OFF** is completed, **OFF** letter seen on the screen, screen light turns off, now the combi boiler is in OFF mode.



To bring combi boiler in OFF mode while it is in WINTER;



When the **MODE** button is hold, while screen light is on after the cycle **OFF** is completed, **SUMMER** mode.



Then, when the same transaction is repeated, after cycle is completed **OFF** letter is seen on the screen screen light turns off, your combi is now at STANDBY position.

CH: (System) Central Heating

DHW: Domestic Hot Water

Operating modes and related notifications:

OPERATING MODES EXPLANATIONS:

- **CLOSED** or **OFF** (3 digits LCD screen)
- **WINTER**▶ Radiator temperature + °C + tap + radiator is displayed.
- **SUMMER**▶ Radiator temperature + °C + tap is displayed.

Important: It is compulsory to have two different lines according to legal regulations being in force regarding electrical installations in case of using a thermostat On/Off on the Remote Control. It is not allowed to use any pipe or hose of the combi boiler as electricity or phone earthing line. That must be ensured prior to making electrical connections of the combi boiler.

- **CH ON**▶ Radiator Temperature + °C + tap + flashing radiator (symbol) is displayed.
- **DHW ON**▶ DHW temperature + °C + flashing tap (symbol) is displayed.
- **CH FROST PROTECTION**▶ Radiator temperature + °C + flashing radiator (symbol) + when boiler is ignited flame (symbol) is displayed.

- **DHW FROST PROTECTION**▶ CH temperature + °C flashing radiator and tap (symbol) + when boiler ignited flame (symbol)
- **CH/DHW SETTING CHANGE**▶ CH adjustment change will be activated when radiator symbol rapidly flashes. DHW adjustment change will be activated when tap symbol rapidly flashes.
- Service technician function radiator + tap displayed. (Only for authorized service, wait for the function to end without touching.)

3.1.2. Selection of On/Off/Stand-by and



Room thermostat should be installed at 1,25 and 1,50 m height from ground and at least 30 cm distance.



At least 30 cm distance should be available from doors and windows open for air circulation.

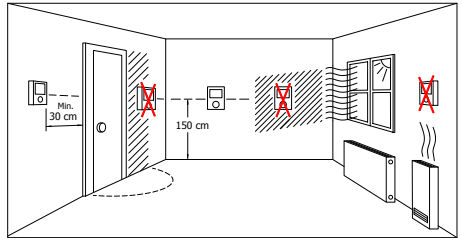

Figure 42 Thermostat position

Summer/Winter Modes

The boiler panel does not have **ON/OFF** button. The boiler must be turned on/off by using the V circuit breaker to be connected to the boiler circuit.

3.1.3. On/Off/Stand-by Positions

The boiler panel does not have **ON/OFF** button. The boiler must be turned on/off by using the V circuit breaker connected to the boiler circuit.

3.1.4. Operation in Winter Mode

At that position, combi boiler operates both for heating the environment and providing Domestic Hot Water. Radiator (CH) temperature adjustment is made with (3) and (4) numbered buttons in Figure 40, Domestic Hot

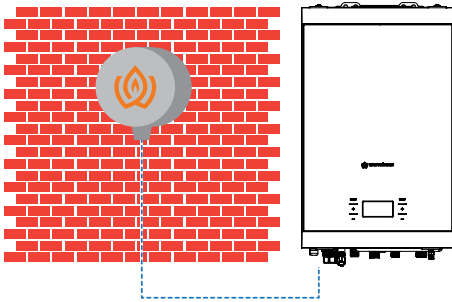

Figure 49 Combi boiler controlled by Outside Sensor

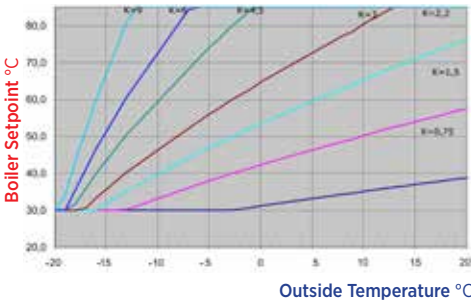

Figure 50 Outside weather temperature sensor operation curves

Water. temperature adjustment is made with (6) and (7) numbered buttons and this temperature is indicated with (9) numbered indicator for Radiator (CH) and with (11) numbered indicator for Domestic Hot Water.

3.1.5. Operation in Summer Mode

Combi boiler only operates for heating the domestic hot water in this mode. In order to switch to tap water position;

3.1.6. Use with Room Thermostat (Optional)

Combi boiler has initial preparation for remote control connection via environment thermostats being sold as optional sets. All Warmhaus thermostats can be connected with dual-wired cables. Carefully read user's and installation instructions given in the Accessory set. Thanks to control units with room thermostat having program clock, you can control your combi boiler at installation place, operating based on room temperature and also adjust different uses depending on each day of the week.

General Utilisation Type

- Please consult our authorized services for room thermostats compatible with Warmhaus combi boiler.
- Do not remove device components during operation.
- Do not place at a position allowing direct sunlight exposure or near heat sources.
- Manufacturer company shall not be responsible for below given situations:
 - a) Faulty installation
 - b) Making intervention on the device by unauthorized persons
 - c) Failing to follow instructions given in this book and room thermostat booklets

Installation Instruction: Device installation shall only be performed by the Warmhaus Authorized Service. The dual cable required for installation is supplied by the dealer/consumer.

Maintenance and Service Life: Warmhaus room thermostat should not come into contact with water or excessive humidity. Unless an external damage occurs, the room thermostat does not require any maintenance.

3.1.7. Use of Outside Temperature Sensor (Optional)

Outside Weather Temperature Sensor (optional) can be installed in your combi boiler by our Authorized Service (see: Installation Section; Accessory Connection Scheme), and you can enable automatic temperature adjustment for the radiator with immediate responses to outside weather temperature changes via smart and comfort operation. Therefore, it maintains an efficient and economic operation by reducing the radiator water



Figure 51 Ending the deairation function

Error Code	Description of the Error	Malfunction	Probable Cause	Solution(s)
E 01	Intervention of exhaust Thermostat (Open Combustion Chamber boiler)	Boiler does not work, E01 error code flashing on the screen	> Flue Sensor faulty	1-) Reset & Restart boiler 2-) Call for authorised service
E 02	Low water pressure in the system/system parameter wrongly setted	Boiler does not work, E02 error code flashing on the screen	> Water pressure in the boiler not enough	1-) Fill the boiler 1,2-1,5 bar according to manual 2-) Check if the system pressure 1,2 - 1,5 bar from the manometer located right & bottom of the boiler 3-) Reset & Restart boiler 4-) If problem persist Call for authorised service
E 03	High water pressure in the system	Boiler does not work, E03 error code flashing on the screen	> High Water pressure in the boiler higher than > 2,8 bar	1) First check the filling tap of the boiler and make sure it is closed. 2) During boiler operation, the safety valve may continue to drain water from the drain line, so make sure that this line is connected to a drain line. 3) If your plumbing line has a drain cock; first turn the boiler off and let the pressure drop to 1-1.5 bar, then switch it on again. 4) If the pressure increase occurs again, call an authorized service.
E 04	Domestic heating water temperature sensor faulty	Boiler does not work on DHW mode but still work on Central heating mode, E04 error code flashing on the screen	> Domestic heating water temperature sensor faulty	1-) Call for authorised service
E 05	Central heating FLOW temperature sensor faulty	Boiler does not work, E05 error code flashing on the screen	> Central heating FLOW temperature sensor faulty	1-) RESET boiler at first check if problem removed 2-) Check other gas devices if they are working 3-) Check main gas supply valve is open or not 4-) Check boiler gas supply valve bellow the boiler is open or not 5-) RESET boiler at first check if problem removed 6-) Call for authorised service
E 06	No ignition	Boiler does not work, E06 error code flashing on the screen	> Gas supply failure	1-) RESET boiler at first check if problem removed 2-) Check boiler central heating valves are open if they are closed open all 3-) Check all radiator valves are open if they are closed open minimum 3 meters of radiator must be open 4-) RESET boiler and check if problem removed 5-) Call for authorised service

Error Code	Description of the Error	Malfunction	Probable Cause	Solution(s)
E 07	Safety thermostat intervention	Boiler does not work, E07 error code flashing on the screen	> Lack of water on the system > Pump blockage > Pump failure > Pump harness > Installation blockage	1-) RESET boiler at first check if problem removed 2-) Check boiler central heating valves are open if they are closed open all 3-) Check all radiator valves are open if they are closed open minimum 3 meters of radiator must be open 4-) RESET boiler and check if problem removed 5-) Call for authorised service
E 08	Flame circuit failure	False flame signal from combustion or electrode	> Water blockage on syphon > Electronic board	1-) Call for authorised service
E 09	No water circulation in the system	Boiler does not work, E09 error code flashing on the screen	> Lack of water on the system > Pump blockage > Pump failure > Pump harness > Installation blockage	1-) RESET boiler at first check if problem removed 2-) Check boiler central heating valves are open if they are closed open all 3-) Check all radiator valves are open if they are closed open minimum 3 meters of radiator must be open 4-) RESET boiler and check if problem removed 5-) Call for authorised service
E 11	Gas valve modulator disconnected	Boiler does not work, E11 error code flashing on the screen	> Gas valve harness	1-) Call for authorised service 2-) Check gas valve between board and gas valve
E 13	Exhaust temperature probe over-temperature alarm	Boiler does not work, E13 error code flashing on the screen	> Over temperature flue gas outlet value > 105 C°	1-) Call for authorised service at first
E 14	Exhaust (FLUE) temperature probe fault	Boiler does not work, E14 error code flashing on the screen	> Central heating FLUE temperature sensor faulty	1-) Reset & Restart boiler 2-) Call for authorised service
E 15	Fan failure (feedback/supply)	Boiler does not work, E15 error code flashing on the screen	> Fan harness	1-) Reset & Restart boiler 2-) Call for authorised service
E 16	Central heating temperature RETURN sensor faulty	Boiler does not work, E16 error code flashing on the screen	> Central heating RETURN temperature sensor faulty	1-) Reset & Restart boiler 2-) Call for authorised service
E 17	Temperature difference between FLOW and LIMIT NTC (Double Heating Probe) faulty	FLOW and LIMIT sensor (DOUBLE NTC) malfunction	> FLOW and LIMIT Sensor (double NTC) faulty	1-) Reset & Restart boiler 2-) Call for authorised service

Error Code	Description of the Error	Malfunction	Probable Cause	Solution(s)
E 19	Water flow meter input reading	Lack of domestic heating water on request	Wrong parameters settled on TsP menu	1-) Call for authorised service at first 2-) Only authorised service must adjust TsP Parameter P01=0 with default value
E 20	CH Overtemperature, Temperature Central Heating > TSP 81 value °C	Boiler does not work, E81 error code flashing on the screen	> Lack of water on the system > Pump blockage > Pump failure > Pump harness > Installation blockage	1-) RESET boiler at first check if problem removed 2-) Check boiler central heating valves are open if they are closed open all 3-) Check all radiator valves are open if they are closed open minimum 3 meters of radiator must be open 4-) RESET boiler and check if problem removed 5-) Call for authorised service
E 21	Delta Temperature Central Heating flow and Return > TSP 82 value °C	Boiler does not work, E21 error code flashing on the screen	> Lack of water on the system > Pump blockage > Pump failure > Pump harness > Installation blockage	1-) RESET boiler at first check if problem removed 2-) Check boiler central heating valves are open if they are closed open all 3-) Check all radiator valves are open if they are closed open minimum 3 meters of radiator must be open 4-) RESET boiler and check if problem removed 5-) Call for authorised service
E 28	Maximum allowed consecutive lock-out reset reached	Usable RESET number reached.	Too many consecutive lock-out failures (followed by reset) due to other possible causes	1-) Removing power supply reset will be allowed 2-) Check the root cause of Error code to solve 3-) If fault still persists call for authorised service
E 37	Low voltage anomaly	Boiler does not work, E37 error code flashing on the screen	Low voltage < 165 VAC +/- 5% on the supply network during normal operation OR < 182 VAC +/- 5% during Au-TO calibration mode	1-) Call for Electrical supply network provider 2-) Error will remove if supply voltage > 170 VAC +/- 5% 3-) If this failure is observed during calibration calibration can not be complete unless supply voltage > 188 VAC +/- 5%
E 40	Wrong network frequency survey	Boiler does not work, E40 error code flashing on the screen	Wrong frequency of the electric supply network. Value out of tolerance, 50 Hz +/- 5%	1-) Call for Electrical supply network provider 2-) Error will remove if supply frequency 50 Hz +/- 5%
E 41	Loss of flame more than 6 successive times	Boiler does not work, E41 error code flashing on the screen	> Too many domestic hot water request in short period (1 min) > Low gas pressure	1-) Call for authorised service at first
E 42	Buttons anomaly	Boiler does not work, E42 error code flashing on the screen	Wrong parameters settled on TsP menu	1-) Call For service

Error Code	Description of the Error	Malfunction	Probable Cause	Solution(s)
E 43	Opentherm Communication error	Boiler does not work, E43 error code flashing on the screen after 1 minute of communication error	Opentherm line disconnected	1-) Remove energy from boiler and re energize E43 will be removed and boiler & buttons will get back to functional 2-) Replace the room unit batteries with the fresh ones and reset from room unit 3-) Check cabling between boiler and room unit and re connect if any disconnection, if connection set up successfully then connection symbol (Figure 48, symbol 18) will be activated on the screen 4-) Call for authorised service to re connect opentherm connection
rE 44	Cumulated intermittent ignition without reaching burner ignition.	Boiler does not work, E44 error code flashing on the screen	> Intermittent contacts on harness > Hammer effect on water net > Too many request from in shotr time from out side room units or thermosad bridge etc.	1-) Reset & Restart boiler 2-) Call for authorised service
E 62	Calibration request	Boiler does not work, E62 error code flashing on the screen	> Calibration not done > Replacing board but not service key from the board dismantled > Service key damaged or disconnected > Updating Software (probable)	1-) Call For service
E 72	Delta T heating at ignition not occurred	Boiler does not work, E72 error code flashing on the screen	> FLOW OR RETURN Sensor not on position	1-) Call for authorised service at first 2-) Check RETURN and FLOW sensor on position.
E 74	Second CH temperature Probe faulty	Boiler does not work, E74 error code flashing on the screen	> FLOW and LIMIT Sensor (double NTC) faulty	1-) Reset & Restart boiler 2-) Call for authorised service.
E 77	Absolute current values reached	Boiler does not work, E77 error code flashing on the screen	> Gas inlet pressure > Aging or rust on the electrode > Recirculation on fluegas path > Blokage on flue or wrong flue > Electrode position > Cabling disconnections > Combustion calibration > Electronic board > Gas valve failure	1-) Call for authorised service at first

Error Code	Description of the Error	Malfunction	Probable Cause	Solution(s)
E 78	Max regulation current value reached	Boiler does not work, E78 error code flashing on the screen	<ul style="list-style-type: none"> > Gas inlet pressure > Aging or rust on the electrode > Recirculation on fluegas path > Blokage on flue or wrong flue > Electrode position > Cabling disconnections > Combustion calibration > Electronic board > Gas valve failure 	1-) Call for authorised service at first
E 79	Min regulation current value reached	Boiler does not work, E79 error code flashing on the screen	<ul style="list-style-type: none"> > Gas inlet pressure > Aging or rust on the electrode > Recirculation on fluegas path > Blokage on flue or wrong flue > Electrode position > Cabling disconnections > Combustion calibration > Electronic board > Gas valve failure 	1-) Call for authorised service at first
E 80	Problem on electronic gas valve driver	Boiler does not work, E80 error code flashing on the screen	<ul style="list-style-type: none"> > Electronic board > Gas valve failiure 	1-) Call for authorised service at first
E 81	Lock-out for combustion problem at starting (1)	Boiler does not work, E81 error code flashing on the screen	<ul style="list-style-type: none"> > Strong flue blokage > Combustion problem > Wrong flue > Gas inlet pressure > Aging or rust on the electrode > Recirculation on fluegas path > Electrode position > Combustion calibration 	1-) Call for authorised service at first
E 84	Capacity reduction for detected (supposed) low gas inlet pressure	Boiler operates at limited capacity, E84 error code flashing on the screen	<ul style="list-style-type: none"> > Gas inlet pressure > Combustion problem 	1-) If there is strong wind (ie.wind storm) wait until the wind storm stop then RESET the boiler 2-) IF problem persist Call for authorised service
E 87	Problem on electronic gas valve circuit	Boiler does not work, E87 error code flashing on the screen	<ul style="list-style-type: none"> > Cabling disconnections > Gas valve failiure 	1-) Call for authorised service at first

Error Code	Description of the Error	Malfunction	Probable Cause	Solution(s)
E 88	Fault of electronic gas valve managing circuit	Boiler does not work, E88 error code flashing on the screen	> Cabling disconnections > Gas valve failure	1-) Call for authorised service at first
E 89	Problem on combustion feedback signal	Boiler does not work, E89 error code flashing on the screen	> Aging or rust on the electrode > Recirculation on fluegas path > Blokage on flue or wrong flue > Electrode position > Cabling disconnections > Combustion calibration > Electronic board > Gas valve failure	1-) Call for authorised service at first
E 90	Unable to regulate combustion	Boiler does not work, E90 error code flashing on the screen	> Aging or rust on the electrode > Recirculation on fluegas path > Blokage on flue or wrong flue > Electrode position > Cabling disconnections > Combustion calibration > Electronic board > Gas valve failure	1-) Call for authorised service at first
E 92	Air compensation active	Boiler does not work, E91 error code flashing on the screen	> Possible wind presence > Aging or rust on the electrode > Recirculation on fluegas path > Blokage on flue or wrong flue > Electrode position > Combustion calibration > Min power adjustment	1-) Call for authorised service at first
E 93	Unable to regulate combustion (temporarily)	Boiler does not work, E93 error code flashing on the screen	> Aging or rust on the electrode > Recirculation on fluegas path > Blokage on flue or wrong flue > Electrode position > Combustion calibration > Gas valve failure > Electronic board	1-) Call for authorised service at first

Error Code	Description of the Error	Malfunction	Probable Cause	Solution(s)
E 94	Possible low gas pressure or exhaust recirculation	Boiler does not work, E94 error code flashing on the screen	<ul style="list-style-type: none"> > Gas inlet pressure LOW > Recirculation on fluegas path > Blokage on flue or wrong flue > Aging or rust on the electrode > Electrode position > Combustion calibration > Gas valve failure > Electronic board 	1-) Call for authorised service at first
E 95	Intermittent combustion value	Boiler does not work, E95 error code flashing on the screen	<ul style="list-style-type: none"> > Harness on electrode and earth > Aging or rust on the electrode > Electrode position > Combustion calibration 	1-) Call for authorised service at first
E 96	Flue or air suction way blokage	Boiler does not work, E96 error code flashing on the screen	<ul style="list-style-type: none"> > Blokage on flue > Blokage on air suction path 	1-) Call for authorised service at first
E 98	SW error, board start-up error fault	Boiler does not work, E98 error code flashing on the screen	<ul style="list-style-type: none"> > Boiler software problem 	1-) Call for authorised service at first
E 99	Generic fault	Boiler does not work, E99 error code flashing on the screen	<ul style="list-style-type: none"> > Boiler electronic hardware problem 	<ul style="list-style-type: none"> 1-) Reset & Restart boiler 2-) Call for authorised service at first

(1) Call the Authorized Service if failure continues.

(2) 81 numbered failure corresponds any blocking in the exhaust gas pipe. In such case, you should consult the authorized service technician before re-starting the combi boiler.

temperature when outside weather temperature increases and gradually increasing the radiator water temperature when outside weather temperature decreases and sets you free from making radiator temperature adjustments. This sensor is activated when connected independently from the typology or availability of used thermostat, the relation between output temperature and outside temperature is defined according to curves given in the graphic below based on position of button located on the combi boiler panel.

After connecting the Outside Sensor, adjustment is made according to average external weather temperature of your province with P04 parameter. Our authorized service will make this adjustment during installation.

3.1.8. Customizing Combi Boiler Features

As your combi boiler has an advanced electronic card, operation conditions and certain parameters related with your preferences may be changed by our Authorized Service. Please consult our authorized service when any changes requested in below given parameters.

(P07) Controlled Power Increase Period.

When combi boiler starts, it uses a controlled period defined for reaching the adjusted maximum heating power. This period is adjusted as 10 minutes as standard and can be increased up to 10 minutes.

(P08) Radiator (Heating) Power.

The combi boiler automatically operates with variable gas flow rates depending on heat load of installation between the minimum and maximum power.

(P21) Low temperature region selection.

This parameter should be adjusted as 1 for ground heating or heating systems operating with low temperature. 0 (zero) value is selected for radiator systems to operate at high temperatures as standard.

(P24) Child Protection

This parameter is not active as standard, please consult our Authorized Service for activating the parameter (Protection lock is activated when parameter is adjusted as 1). Buttons are locked after 2 minutes following use of buttons when the function is active. Keylock is opened when the MODE button is hold until cycle is completed for getting off the child protection. Your combi boiler is under control against setting changes upon activation of this feature.

(P40) CH ignition delay period.

Combi boiler is equipped with an electronic timer for preventing frequent ignition. This period is adjusted as 2 minutes as standard and can be increased up to 10 minutes.

(P42) Ready Hot Water

(Pre-Heating passive/active).

In order to rapidly prepare DHW faster and reducing the cold water consumption during waiting, grid water is heated in the plate exchanger and ready hot water is stored.

Activation of this function is performed with parametric adjustment by our Authorized Service depending on your request.

Air Deaeration Function

The boiler has to be switched to OFF mode first. It is possible to activate deaeration function pressing RESET and "-" for circle time.

"Air" will be displayed on the screen. Boiler will start the Deaeration function.

During this function pump and 3-way valve are activated/deactivated in order to have deaeration of the hydraulic plant.

This function ends pushing again RESET and "-" for circle time or at the end of deaeration time: 12 minutes.

3.2. RECOMMENDATIONS FOR ECONOMICAL USE OF COMBI BOILER

Your combi boiler is adjusted at ECO mode for economic use, we recommend not to change.

Correct Capacity Selection

Heat loss calculation of the combi boiler location should be made correctly and combi boiler capacity should comply with this calculation. Devices not having adequate capacity shall give late responses to heating requests, devices with higher capacity may cause discomfort and more fuel consumption as they more frequently opened and closed. Therefore, combi boiler capacities should be selected according to the place used.

Insulation

Insulation of your building is the most important item reducing the heat loss and gas consumption. However, as your combi boiler has the highest thickness insulation of its class, heat loss is minimized.

Radiators

Ensure balancing our pressure distribution of your radiator installation within the house by making reduction adjustments from radiator valves. Placing furnitures in front of radiators prevents air circulation and causes discomfort and more fuel consumption. Reducing radiator valves of rooms not used for a long period or if thermostatic radiator valve is used, bringing to the lowest position then, closing room doors will provide saving.

Domestic Hot Water

Always adjust the domestic hot water temperature as (38-42 °C). Adjustment of temperature adjuster as

low ensures a considerable power saving. In addition, high domestic hot water temperatures cause strong calcification and that negatively affects operation of the device (for instance, longer heating periods, less flow rate).

Thermostatic Radiator Valves

You can both acquire savings and comfort by balancing the heat distribution among the house by using Thermostatic Radiator Valves.

Room Thermostats

Your combi boiler will operate more economically as you will have the chance to adjust requested room temperature according to comfort and economy timings via room thermostats. Thus, you can adjust temperature of your room as you wish, and also you can acquire approximately 6% power saving with every degree of temperature decrease.

Ventilation

Do not leave windows slightly open for ventilating room/rooms. In such case, continuous heat loss will occur and not having any certain improvement in the room air.

Fully opening windows for a short period provides a better result. Bring thermostatic radiator valves to lowest position when ventilating rooms.

Cleaning And Maintenance

Attention: to preserve the boiler's integrity and keep the safety features, performance and reliability, which distinguish it, unchanged over time, you must at least execute maintenance operations on a yearly basis in compliance with what is stated in the relative point at "annual check and maintenance of the appliance", in compliance with national, regional, or local standards in force.

We recommend stipulating a yearly cleaning and maintenance contract with an authorised local firm.

3.3. ISSUES REQUIRED TO BE TAKEN INTO CONSIDERATION FOR WARRANTY CONDITIONS

This warranty given by WARMHAUS does not cover elimination of failures arising from abnormal use of the product and also out of the warranty scope for below given situations

1. Damages and failures occurring in devices which are not first started by Warmhaus Authorized Services,
2. Damages and failures arising from use of the product contrary to items given in User's Manual and using out of its intended purpose.
3. Damages and failures arising from wrong type

selection,

4. Damages and failures arising from maintenance and repairs performed by persons other than our Authorized Services,
5. Damages and failures occurring due to transportation, unloading, loading, storing, external physical (Crushing, scratches, fractures) and chemical factors following delivery of the Product,
6. Damages and failures arising from fire and lightning,
7. Damages and failures arising from false fuel use and fuel characteristics,
8. Low or excessive voltage; unearthed socket usage;
9. Damages and failures arising from faulty electricity installations,
10. Damages and failures arising from failing to perform timely annual maintenance
11. And cleaning, defined periodical maintenance operations by our Authorized Services,
12. Damages and failures those may occur in the device or usage area due to other products and accessories used in a system with the device subject to the Warranty,
13. Damages and failures arising from frost/icing or occurring due to using in the outdoor places (open balcony, etc.).
14. Altering the Registry Label and Warranty Certificate,
15. Damages and failures arising from using water out of the water values defined in device user's guide,

Elimination of above mentioned failures shall be performed against payment.

Our distinguished customer, we believe the importance of providing good products to you as well as rendering good services.

Recommendations and Data to be Followed:

1. When first start of your combi boiler is done, please keep the technical service document given by the Authorized Service and a copy of device invoice and the Warranty Document approved by your Authorized Dealer.
2. Use your product according to principles of installation and operation guide.
3. Keep the "SERVICE DOCUMENT" if received from your service technician following the service taken. The Service Document will be beneficial for you in any problems those may occur in your device in the future.

TECHNICAL DATA		UNIT	WARMHAUS			
			Minerwa-ErP 25			
CE certification			CE-1015CT0706.18 ??			
Gas Circuit						
Gas type			G20	G25	G30	G31
Gas supply pressure		mbar	20	25	30	37
Gas Consumption at Maximum		m ³ /h	2,38*	2,85	0,728	0,92
Gas Consumption at Minimum		m ³ /h	0,37*	0,43	0,107	0,105
*(Natural Gas G20) Heat Load (Hu=10,56 kWh/m ³)						
Premix System			Gas Adaptive			
Modulation Range			01:10			
Heat Exchanger Material			Stainless steel			
Efficiency			G20	G25	G30	G31
(80/60 °C) Efficiency at Maximum Heat Output		%	98,03	97,84	97,48	97,76
(50/30 °C) Efficiency at Maximum Heat Output		%	105,11	105,34	101,95	103,63
Efficiency at 30% load at 36/30 °C		%	108,29	108,38	104,28	108,29
Seasonal space heating energy efficiency (expressed in terms of GCV)		%	92 (Class A)			
Radiator Circuit			G20	G25	G30	G31
Maximum heat input Qn		kW	24,25	24,25	24,25	24,25
Minimum heat input Qn		kW	3,5	3,5	3,5	2,8
Maximum Heat Output Pn (80/60 °C)		kW	23,7	23,7	23,6	23,7
Minimum Heat Output Pn (80/60 °C)		kW	3	3	3,2	2,5
Maximum Heat Output Pn (50/30 °C)		kW	25	25	24,33	25
Minimum Heat Output Pn (50/30 °C)		kW	3,6	3,6	3,55	2,9
Temperature selection range (min+max) high temperature		°C	25+80			
Temperature selection range (min+max) low temperature		°C	25+47			
Operating Pressure (Maximum)		bar	3			
Operating Pressure (Minimum)		bar	0,5			
Expansion tank useful volume		bar	7			
Pump pressure (at 1000 l/h flow rate)		mH ₂ O	7			
Pump pressure (at 500 l/h flow rate)		mH ₂ O	7,3			
Max. Pump Flow Rate		l/h	2500			
Pump Energy Efficiency Index		EEl	≤ 0,20			
Domestic Hot Water Circuit						
Maximum DHW Heat Input		kW	31,15			
Minimum DHW Heat Input		kW	3,5			
Max. Domestic Hot Water flow rate (Δt: 35 °C)		l/min.	12,8			
Max. Domestic Hot Water flow rate (Δt: 30 °C)		l/min.	14,8			
Max. Domestic Hot Water flow rate (Δt: 25 °C)		l/min.	17,7			
Min. Domestic Hot Water flow rate (for the DHW function activation)		l/min.	1,5			
Maximum water pressure		bar	10			
Minimum water pressure		bar	0,5			
Temperature adjustment range		°C	35 - 60			
Temperature adjustment precision		°C				
Electricity Circuit						
Electricity Supply		V AC-50 Hz	230 V +%10- %15			
Electricity Consumption (Max./Min.)		Watt	95 / 55			
Protection Index		IP	IPX5D			
Exhaust Gas Circuit			G20	G25	G30	G31
Flue temperature (Qn)						
(80/60 °C) Exhaust gas temperature (Min. / Max.)		°C	69,3 / 70,5	64,6 / 70,2	57,1 / 70,0	59,9 / 69,7
(50/30 °C) Exhaust gas temperature (Min. / Max.)		°C	48,5 / 50,5	47,7 / 49,4	42,8 / 57,0	47,0 / 50,5
Maximum exhaust gas temperature [Maximum DHW mode]		°C	70			
NOx		Class	6			
Weighted value of Nox (GCV)		mg/kWh	20	19	42	31
Flue mass flow rate (60/80°C - Qn) Nominal/Minimum		g/s	10,32 / 1,6	10,78 / 1,62	10,58 / 1,26	9,91 / 1,18
Flue mass flow rate (60/80°C - Qn) [Maximum DHW mode]		g/s	14,01	14,04	13,58	12,71
Fan head loss		Pa	35 ÷ 140			
General						
Dimensions (H x W X D)		mm	595 x 379 x 260			
Sound Level		dB (A)	55			
Hydraulic Group Material			Brass			
Net Weight		kg	26			
Packed Device Weight		kg	29			
Type			C13, C33, C53, C63, C83, C93, C103, B23, B23P, B33, B33P, B53, B53P			
Category			I2H, I2E, I2E(S) - (G20=20 mbar), I2E+, I2L, I2ELL - (G25=25 mbar) I3P - (G31=37 mbar) I12ELL3B/P, I12H3B/P - (G30=30 mbar)			

Product FICHE & ErP Data

	Manufacturer	Type-model / Technical data	
ErP Data	Warmhaus	Minerwa 25 Boiler	
All information in the ERP Data Sheet & Product Data Sheet is based on the test results of the SZU Test / BRNO laboratories.			
PRODUCT FICHE (according to EU regulation No 811/2013 and 814/2013)			
		Minerwa 25	Minerwa 25
Space heating - Temperature application		High / Medium / Low	High / Medium / Low
Water heating - Declared load profile		L	XL
Seasonal space heating energy efficiency class		A	A
Water heating energy efficiency class		A	A
Rated heat output (Prated or Psup)		kW	24
Space heating - annual energy consumption	Q _{HE}	GJ (**)	42,14
Water heating - Annual energy consumption		kWh (*)	26
		GJ (**)	11
Seasonal space heating energy efficiency		%	92
Water heating energy efficiency		%	84
Sound power level LWA indoors		dB	55
Option to only operate during low demand periods		—	—
Specific precautions for assembly, installation and maintenance			Before any assembly, installation or maintenance the user and installation manual has to be read attentively and to be followed
All the data that is included in the product information was determined by applying the specifications of the relevant European directives. Differences to product information listed elsewhere may result in different test conditions. Only the data that is contained in this product information is applicable and valid.			
(*) Electricity			
(**) Fuel (Natural Gas - G20)			

HANDING OVER

After completing the installation and commissioning of the system the installer should hand over to the householder by the following actions:

1. Make the householder aware that the user instructions are located in the pocket in the drop down door and explain his/her responsibilities under the relevant national regulations.
2. Explain and demonstrate the lighting and shutting down procedures.
3. The operation of the boiler and the use and adjustment of all system controls should be fully explained to the householder, to ensure the greatest possible fuel economy consistent with the household requirements of both heating and hot water consumption. Advise the User of the precautions necessary to prevent damage to the system and to the building, in the event of the system remaining inoperative during frosty conditions.
4. Explain the function and the use of the boiler heating and domestic hot water controls.

Explain that due to system variations and seasonal temperature fluctuations DHW flow rates/temperature rise will vary, requiring adjustment at the draw off tap. It is therefore necessary to draw the users attention to the section in the Users Instructions titled "Control of Water Temperature" and the following statement: "Additionally, the temperature can be controlled by the user via the draw-off tap: the lower the rate the higher the temperature, and vice versa".

ErP DATA (according to EU regulation No 813/2013 and 814/2013)

			Minerwa 25	Minerwa 25
Water heating - Declared load profile			L	XL
Rated Heat Output	Prated	kW	24	24
Useful heat output at rated heat output and high temperature regime (2)	**P _d	kW	23,7	23,7
Useful heat output at 30% of rated heat output and low temperature regime (1)	**P ₁	kW	4,16	4,16
Seasonal Space Heating Energy Efficiency	η _s	%	92	92
Useful efficiency at rated heat output and high temperature regime(2)	**η _d	%	87,57	87,57
Useful efficiency at 30% of rated heat output and low temperature regime(1)	**η ₁	%	97,48	97,48
Auxiliary Electricity Consumption				
Full load	elmax	kW	0,43	0,43
Part load	elmin	kW	0,11	0,11
Standby mode	P _{SB}	kW	0,005	0,005
Other Items				
Standby heat loss	P _{Stby}	kW	0,027	0,027
Ignition burner power consumption	P _{ign}	kW	0,000	0,000
Space heating - annual energy consumption	Q _{HE}	GJ	42	42,14
Sound power level, indoors	L _{WA}	dB	55	55
Emissions of nitrogen oxides	**NO _x	mg/kWh	20	20
Domestic Hot Water Parameters				
Declared Load Profile			L	XL
Daily electricity consumption	Q _{elec}	kWh	0,117	0,169
Annual electricity consumption*	AEC	kWh	26	37
Water Heating Energy Efficiency	h _{wh}	%	81	84
Daily fuel consumption	Q _{fuel}	kWh	14,809	23,152
Annual fuel consumption	AFC	GJ	11	18
Condensing boiler	—		Yes	Yes
Low temperature boiler	—		Yes	Yes
Combination boiler	—		Yes	Yes
BI Boiler	—		No	No
Room boiler with combined heat and power	—		No	No
Auxiliary boiler	—		No	No
Brand Name	Warmhaus			
Manufacturer adress	Warmhaus Isıtma ve Sogutma Sistemleri San. Tic. A.Ş. Işıktepe OSB Mah. Park Cad. No:10 16140 Nilüfer - Bursa / Turkey			
Warnings 	All specific precautions for assembly, installation and maintenance are described in the operating and installation manual. Read and follow the operating and installation manual.			
	Read and follow the operating and installation manual regarding assembly, installation, maintenance, removal, recycling and/or disposal.			
* for average climatic conditions	**Natural Gas (G20)			
(1) Low temperature means for condensing boilers 30 °C, for low temperature boilers 37 °C and for other heaters 50 °C return temperature (at heater inlet).				
(2) High temperature regime means 60 °C return temperature at heater inlet and 80 °C feed temperature at heater outlet.				
Author: İsmail B. Taşdemir / R&D Mng. Release date: 26/04/17 Rev. No: 0 Drw. No: WH.17.128	As this is the property of Warmhaus Isıtma ve Sogutma Sistemleri San. Tic. A.Ş. It must not be passed on to any person not authorized by Warmhaus Isıtma ve Sogutma Sistemleri San. Tic. A.Ş or be copied or otherwise utilized by anybody without expressed written permission.			



warmhaus

Minerwa 25



A



A

55 dB

25 kW

2019

811/2013

MINERWA

CONDENSING COMBI BOILER INSTALLATION & USER MANUAL

Minerwa Installation & User Manual code: 150.11.606.000081
Revision Date: R00/09.2019